



New Zealand
Potter

New Zealand Potter
Volume 28, Number 1, 1986

McSkimming's Clay.



Range of first class clays available from the following outlets:

C.C.G. INDUSTRIES LTD.
33 Crowhurst Street, Newmarket.

COASTAL CERAMICS
124 Rimu Road, Paraparaumu.

**COBCRAFT POTTERY
SUPPLIES LTD.**
388 Montreal Street, Christchurch.

McSKIMMING INDUSTRIES LTD.
322 Tuam Street, Christchurch.
Main North Road, Waikiwi, Invercargill.

SOUTH STREET GALLERY
10 Nile Street, Nelson.

**SOUTHERN CERAMIC
IMPORT COY.**
No. 1 R.D. Invercargill.

STUDIO 803
803 Eaton Road, Hastings.

TALISMAN POTTERY SUPPLIES
171 Archers Road, Takapuna.

WESTERN POTTERS SUPPLIES
18 Clark Street, New Lynn, Auckland.
Northway Street, Te Rapa, Hamilton.
65 Bridgman Street, Dunedin.



McSkimming Industries Limited

P.O. Box 2105, Dunedin. Telephone 883119. Telex NZ 5320.

C.1409



New Zealand Potter
Vol 28/1 1986

ISSN 0028-8608

Price \$5

Cover: Detail of glass in "Vessel" by Bob Shay; photo by Elaine Comer. See pages 11, 12.

Editor: **Howard Williams**
Assistant Editors: **Ngarie Mulholland**
and Glenys Marshall-Inman
Advertising manager: **John Deal**
Design: **Howard Williams**
Correspondents: **Hamilton, Sue Knowles; Wellington, Anneke Borren; Nelson, Julie Warren, Peter Gibbs; Christchurch, David Brokenshire.**

A DESLANDES
publication, also
publishers of the *New Zealand Journal of Agriculture and the New Zealand Gardener.*
Managing director:
Alex Dunnett
Managing editor:
Jim Moffat

Distribution: Direct
from the publisher at
Private Bag, Petone.
Telephone 687-179.

- 2 Through the Filter Press — Bob Heatherbell
- 2 Letter to the Editor
- 4 Book Review and Craft Loans Scheme
- 6 Borland Pottery School — Glenda Drummond
- 10 Peter Lange Exhibition — Anneke Borren
- 11 Bob Shay — Howard S. Williams
- 14 The Log — John Green
- 15 Murray Clayton — Daphne Hendrie
- 16 Canterbury '86
- 17 Waikato Society of Potters — Don McArthur
- 20 Waikato Society of Potters Exhibition
- 23 J.K. Potteries
- 24 Ancient Pots and Potters — Alison Holcroft
- 28 Hand Craft Potters — Harry Davis
- 32 Pitfiring without a Pit — Peter Gibbs
- 34 Theo Schoon — Steve Rumsey
- 37 Inexpensive Spray Gun — Andy Pretious
- 38 Casey Ginn Raku Workshop — Graham Egarr
- 39 Otago Potters Group
- 40 The Collectors — Don Long
- 43 Ngarie Mulholland and Glenys Marshall-Inman
- 44 Auckland Studio Potters Exhibition
- 46 International Ceramic Symposium — Royce McGlashen
- 48 Beyond Craft. NatWest Award 1985
- 49 Exhibition Calendar
Potters Market

The *New Zealand Potter* is published three times a year, in April, August and December. The price is \$5 per copy, or \$15 pa by subscription. Overseas subscriptions: Australia \$A20; Canada and the United States \$US24; United Kingdom £10; other \$US24.

Articles in the *New Zealand Potter* are copyright and may not be reproduced in any form in whole or in part without the written permission of the publisher. All rights reserved in material accepted for publication unless initially specified otherwise. The editor invites submissions but retains the right to accept or reject any material. No responsibility is accepted for unsolicited articles, photographs or artwork and any submissions will be returned only if accompanied by a stamped addressed envelope. All queries must be accompanied by a stamped addressed envelope, unless intended as letters to the editor.

Typeset and printed by Deslandes Ltd at Publication House, 22 Waione Street, Petone.
Postal address for editorial, advertising and subscriptions: New Zealand Potter, Private Bag, Petone.
Telephone 687-179.

Display advertising

4-COLOUR
Back Cover: \$1500 (minimum three issues)
Full page: \$690
Half page: \$500

BLACK and WHITE
Inside front and inside back covers: \$484
Full page: \$440 Half page: \$269
Quarter page: \$163

Potter's Market:

Display advertising: Full page: \$380 Half page: \$230 Quarter page: \$140 Eighth page: \$85
Classified advertisements will be charged at 50 cents per word, minimum 10 words. Cash with order.
Unless finished art work is supplied by the advertiser, cost of preparing such copy will be added to the above rates.



Some Thoughts on our National Exhibition By Bob Heatherbell, Vice-president, NZSP

Some years ago now when I first developed an interest in pottery, as a hobby at that time, I attended a *New Zealand Society of Potters* Convention being held in Auckland including the National Exhibition.

Col Levy from Australia was the guest. I can recall the buzz, the excitement and the sparkle and it seemed that anyone who was anyone was there.

Nowadays I don't get all these feelings about our exhibition. I realise that part of the reason is that they have become too familiar to me but nevertheless there seems to be a sameness about each one, and despite a lot of effort, a slow loss of vitality. If you stop to remember that we've been doing the same sort of exhibition for around a quarter of a century it's not surprising that the present format has become a little stale.

Change can be most unsettling but it can also be an invigorating process as witness the energy that poured into the society at Palmerston North not long ago with the changes in attitudes to membership. I believe that now potters must accept changes in the way we present and promote ourselves and this includes our National Exhibition. Fortunately some changes are beginning and our developing relationship with the art galleries, while yet tentative, is moving in the right direction.

Potters whose only interest is domestic ware may be suspicious of this flirtation with the arts but they can rest assured that they are far from forgotten. After all, useful pots will always be the foundation of our craft, and your council is always perfectly aware of this.

I personally believe that our time-worn system of selection should be up

for review and up for change. I readily concede that pot selection of some kind will always be necessary in certain types of events, but I doubt its validity in more aesthetic areas. Selection of pots which is supposed to "protect our standards" is of course a useful device to get the right number of pots to fill a given space, but will the exhibition be the potters' exhibition or will it be the selector's exhibition?

Invited exhibitions are nothing new but could well be looked at as an option on a national scale. This would amount to selecting the potter but not his or her work, making them entirely responsible for their own reputations. The selection of the potter rather than the work would undoubtedly be even more controversial, but whatever the problems involved I believe the resulting exhibitions would be infinitely more varied, vibrant and exciting. The art galleries would go a step further with their curatorial approach and proof of quality workmanship and professional ability and maturity is required before anyone gets an invitation to exhibit at all.

The promotion of pottery as a ceramic art form is, I believe, an important part of the society's work. Any advance we can make to further our status and acceptability in the art world will provide a spin-off to all potters, not just those who are immediately involved.

The Christchurch National Convention is almost here and your council is reviewing the society's future directions. Be there and give your views. It is all too easy for us to lose touch with grass roots opinions. Don't forget, anyone who is anyone should be there!

AWARDS GIVEN

Cliff Whiting of Northland is to be congratulated on his being selected by *QE II Arts Council* as the recipient of the \$25,000 *Alan Highet Award*. This has been given not only for his own work in painting, carving, sculpture and murals, but also for his extremely valuable contribution to contemporary Maori art and crafts on many *Maraes*. We remember Cliff when he was on the staff of the *Palmerston North Teachers College* at the time of the *NZSP Symposium, Ceramics '81*.

In the USA, **Sam Maloof**, a famous California woodworker, has been given a USA\$300,000 *MacArthur Fellowship*. The first craftsman ever to be so honoured, he will receive USA\$60,000 tax free each year for five years to 'fund creative interests, with no strings attached.' The fellowships, initiated in 1978 in the will of insurance company owner *John D MacArthur*, are designed to free extraordinary minds to pursue their own paths whether in the sciences, arts, human rights, or other areas. Nominators and adjudicators for the fellowships are strictly anonymous. Maloof was reportedly 'flabbergasted' to hear the news since he had not even known he was being considered.

"Tourism is to many countries an alternative agriculture which can turn even the bad lands green." *Laurie Lee*.

New Zealand Potter is grateful for a generous grant from Winstone Quarries towards publication costs.



LETTER TO THE EDITOR

Sir,

Katherine Sanderson, in *Through the Filter Press* in your last issue, raises a number of points about craft advertising that parallel some long-held opinions of my own.

My qualifications for holding such opinions is that, although a mere hobby potter, I am a journalist with 35 years experience of newspapers. I am also a qualified associate of the *New Zealand Institute of Management* and for several years tutored their advertising and salesmanship courses in Wanganui.

Advertising always pays — provided it is done properly and in the right place.

The solution is to do exactly what **Katherine Sanderson** suggests, and it is probably less difficult and less costly than many believe.

In 1981 advertisements were running on TV for *Selangor* pewter — and those advertisements were also selling pots. Not in vast numbers of course and the potter would not have been aware of the link, but it was happening.

The reason is that those advertisements had the effect of diverting some persons about to buy a gift, from something perhaps purely practical to something more decorative. It may have been pewter — it may also have been pottery.

Money is easily diverted from one product to another, provided the buyer is nudged toward a change. *Air New Zealand* has a near monopoly of major internal airline routes, yet it still advertises. It is competing with sellers of carpet, cameras, rental car companies — all potential recipients of the money that may, or may not, be spent on air fares.

Every time there is a promotion for a particular brand product, all similar brands experience increased sales. People are turned on to buy that kind of article, but may buy a different brand from the shop where they usually deal, or buy a product better suited to their individual needs.

The 'shotgun' and 'time-lag' effects of advertising are both major problems for big companies. They cannot promote their own product without promoting opposition products as well, and they never know how much of this year's income is attributable to last year's advertising. But both these effects can be made to work for potters.

The simplest way of putting what **Katherine Sanderson** advocates into practice is to do in the glossies and the biggest circulation newspapers what

the national distributors do. Run an eye-catching advertisement followed by a list of local suppliers. It would benefit everybody, but does that matter? Those whose names and addresses appeared would reap the major benefit. I think a TV spot showing a striking pot and a simple message — "Buy local pottery for gifts this Christmas" would really pay.

Some potters continue to give the impression that they do not want to sell their pots, or will sell them only on their own terms. They do not even sign their work. To me, as a buyer, that is totally unacceptable, I understand the tradition of the anonymous craftsman, but that legendary artisan did not have to make his living in competition with products effectively and expensively promoted.

Advertising and salesmanship are crafts that can be learned and applied like any other craft. On page 35 of the June-August issue of *Ceramics Monthly* there begins a long article on *How to Sell Your Pots Profitably* by **Ross Murphy**. It is well worth reading and taking seriously, with adjustments for New Zealand conditions.

A newspaper that does not reach its readers is no newspaper.

A pot that does not sell may be a thing of beauty and a joy forever, and in 1000 years it will not matter that the potter starved to death because it did not sell. But I suggest that here and now, it is a matter of some concern to the potter.

*David Calder
Wanganui*

"CANTERBURY '86"

The Convention and
28th National Exhibition
of the NZ Society of Potters (Inc)

Christchurch, 16th to 18th May,
1986

For information write to:

The Organising Committee
"Canterbury '86"
PO Box 29-208
Christchurch.

THE EDITOR REPLIES

In our last issue there was a letter pointing out the obtrusiveness of the advertisements which are now appearing in the editorial body of the *NZ POTTER*, and several other readers have aired the same concern.

Your editor does not like them either, but — these advertisers are paying a premium rate to appear on these pages, which enables the magazine to have 8 pages of colour. I'm sure everyone agrees the colour photographs improve the magazine immensely — it's sort of one step back to gain five steps forward.

The *NZ POTTER* should sell more copies because of its colour — if we could sell a few more hundred subscriptions we would soon be able to finance the colour pages without relying on those good advertisers who now support us so generously.

The crunch then, Dearest Reader, is have you bought this copy you are at this moment reading? If it belongs to a friend, or is the club's, co-operative's or night class copy — and you are enjoying reading it — please buy a copy of your own, or even better, take out a yearly subscription. As more people buy, we can produce an even better magazine.

To answer another reader's query; file folders are now available from the publishers at \$10. They hold 9 issues (3 years) of *NZ POTTER*. At the end of next year we will supply an index of the contents of the previous 3 years' issues.

In our next issue (August) there will be a column written by a highly qualified accountant, answering readers questions on *GST* and what it will mean to potters.

Please send in, by the end of May, any questions you want answered on this subject.

Editor, *NZ POTTER*
PO Box 79
Albany

WOOPS!

On page 4 of our last issue there appeared a recipe for *Lizard Skin* raku glaze. The Manganese Carbonate should have read **Magnesium Carbonate**. This gives the glaze its crackle. Thank you **Joan Litchfield** and **Una Sharpley** for drawing attention to this error. Compare this glaze with the *Lizard* glaze in **Bob Shay's** chart in this issue.

POTTERY IN NEW ZEALAND Commercial and Collectable

By Gail Lambert (Heinemann, \$34.95)

Don't let the title *Pottery in New Zealand* deceive you — this book has very little to do with studio craft pottery. A better indication of its contents is the cover photo of the well known chunky white cup and saucer made by Crown Lynn during the 1940s-50s for New Zealand Railways. In fact it covers the history of industrial and commercial pottery — people, places and pots — in this country from the year dot to the present.

Flicking through the book, aimlessly looking at photos of all that old-fashioned stuff, examples of which may still be found lurking in the back of many mothers' cupboards, a present-day studio potter may be tempted to replace it on a bookshelf unread. But hang on a minute — reading bits of it proves fascinating, and suddenly one wants to start at the beginning, becoming involved in the whole story of the development of commercial ceramics in this country, from bricks and sewer pipes, to the latest range of dinner ware.

For instance did you know that the aforementioned NZR cup and saucer, the butt of many a potter's joke, started out in 1941 being a handleless mug from the *Specials Department* of the *Amalgamated Brick and Tile Co*?

"During the early years of the war, the specials department was declared an essential industry and moved into the production of vitrified mugs and cereal bowls for the American armed forces stationed in the Pacific. These were thick and heavy in accordance with the American specification supplied to Amalgamated, the bodies being a putty colour, finished with an opaque white glaze. If this crockery was tossed into the sinks of the ships' galleys with large boiler shovels, as reputed, then it is easy to understand the reason for such solid construction... Amalgamated, at a later date, did produce a white glazed vitrified cup of similar proportions with a block handle, for canteen and industrial use."

The specials department became a separate company in 1948 and assumed the name *Crown Lynn Potteries Ltd*.

Several studio potters are mentioned — for Crown Lynn, "well known studio potter Mirek Smisek produced a range of hand-thrown pots with sgraffito decoration and the trade name 'Bohemian Ware' hand incised on the base".

"A reputed competitor to Crown Lynn, the Vortex Works, supposedly in operation from the late 1940s and whose products were exhibited at Auckland's Alicit Gallery in 1980-81, was later the subject of an article in the *New Zealand Potter*. It was, in fact, 'something of an elaborate ceramic joke perpetrated by ... a devotee of Thirties pottery.'"

The quote is from Peter Sinclair, the pots were by John Parker.

Barry Brickell and Jan Bell are also quoted. Before Jan became a studio potter she worked at the *Fulford's Te Mata Potteries* in Hawkes Bay. The work of Briar Gardner, Jack Laird of *Waimea Potteries* and the chemist/potter Oswald Stephens is recorded.

Pottery in New Zealand tells a fascinating story, covering the birth, travail and demise — and the successes — of dozens of ceramic workshops and factories, most of which you will never have heard. The photographs are excellent and the *Checklist of New Zealand Pottery Marks* will make many readers rummage through their mums' cupboards to identify "commercial and collectable" pieces of ceramic they formerly had no interest in.

Gail Lambert has done her research, and her writing well. The book is a valuable and readable record of New Zealand's ceramic history.

CRAFTS LOANS SCHEME

- The *Development Finance Company*, in conjunction with the *QE II Arts Council*, have devised a scheme to make low interest loans available to craft workers.
- The *Arts Council* has set aside \$30,000 to subsidise loans from the *DFC*. At this time a subsidy of 12.5% will be made to craft workers. This will allow up to \$200,000 to be invested in the craft industry.
- The amount of the loan is dependent on the security available and the ability to repay. No maximum or minimum loan has been established. A maximum term of 5 years is envisaged.

- The interest rate will be set at 12.5% below the current *DFC* interest rate, with this interest rate being reviewed annually. The *Arts Council* will pay the *DFC* the difference between the subsidised rate and the normal funding. The *Arts Council* will also pay any administration fees incurred.
- A monthly capital repayment will usually apply, however, a schedule for repayments to meet individual needs may be worked out.
- The chattels acquired from the proceeds of the loan, would normally become the security required by the *DFC*.
- The objective of the scheme is to assist those craftspeople who are not able because of the nature of their work and the market for crafts, to borrow at current interest rates, to enable them to create an appropriate working and training environment.
- The *Crafts Loan Scheme* may include, but need not be limited to:
 - The purchase of new equipment
 - The building of new equipment
 - The building, or redevelopment of workshop facilities
 - The redevelopment of relocation of a workshop
 - The redevelopment of existing facilities to include training/teaching facilities
- The scheme is envisaged as applying to those craftspeople who have a proven experience and production/exhibition record. These can be individuals, partnerships or co-operatives.
- The scheme will not apply to certain categories of application as they are covered by the *Major Grant Scheme* and *Short Term Grant Scheme*, such as *Creative Projects*, *Research Projects* and *Study Projects* in NZ and Overseas.
- Intending applicants should apply to:

Crafts Loan Scheme
QE II Arts Council
Private Bag
Wellington.

SUMMER SCHOOL IN ITALY

Camping Stage in Rome's Country, 15-30 July 1986. The Low Temperature Technics. Maiolica — Engobes — Raku. Qualified Polyglots Teachers. To receive the program, write to:

Riccardo Paolucci
Via Vecchia Di Napoli
00049 Velletri
Roma
Italy

POTTERY IN NEW ZEALAND

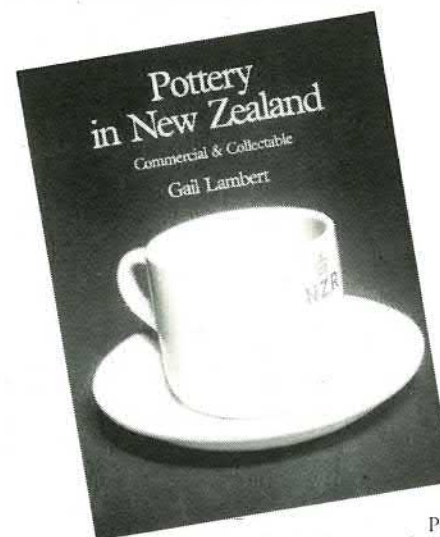

Commercial
and
Collectable

by
Gail
Lambert

Pottery in New Zealand presents for the first time a means of identifying, dating, and eventually valuing the vast range of ceramics produced in this country over the last 130 years. Profusely illustrated with over 200 colour and black/white illustrations of wares ranging from dinner sets to garden urns as well as a comprehensive checklist of New Zealand pottery marks. At \$34.95 this is the perfect gift for anyone with a love of pottery.

HEINEMANN PUBLISHERS P.O. BOX 36-064, AUCKLAND 9



The Dowse Art Museum

collects the fine arts and materials traditionally associated with the crafts.

Congratulate

Barry Brickell on 27 years
as a professional potter.

Art Museum hours

Tuesday to Friday 10 a.m. — 4.30 p.m.
Saturday, Sunday and public holidays
1 p.m. — 5 p.m. Closed every Monday.



Craft Loan Scheme



Queen
Elizabeth II
Arts Council

Development
Finance
Corporation.



Crafts Council

OF NEW ZEALAND (INC.)

craft loans scheme
in conjunction
with the



Applications from those craft people who have a proven experience and production/exhibiting record are now being considered for equipment and workshop development.

Information and application forms available from:

Edith Ryan: Advisory Officer
Queen Elizabeth II Arts Council
Private Bag, Wellington
Telephone: 730-880

Raewyn Smith: Information Officer
Crafts Council of New Zealand
PO Box 498, Wellington
Telephone: 727-018

BORLAND POTTERY SCHOOL

Southland Community College

Hosted by the Otautau Potters Club Inc. Southland

By Glenda Drummond, Otautau.

Southern Fiordland houses a small settlement known as *Borland Lodge* which provides live-in facilities for many groups for both recreational and educational purposes. Otautau potters travel some 80 kms to host the pottery schools, but it is well worth while.

Fiordland offers much for the potter, providing inspiration to satisfy the wildest needs from its natural beauty of beech forests, lichens, lakes and waterfalls, and at higher altitudes the alpine plant world. The moss-carpeted beech forest is a home for countless native birds.

Fiordland offers much for the potter, providing inspiration to satisfy the wildest needs from its natural beauty of beech forests, lichens, lakes and waterfalls, and at higher altitudes the alpine plant world. The moss-carpeted beech forest is a home for countless native birds.

Otautau Potters in conjunction with Southland Community College originally designed the school to provide tuition to Southland potters of all levels; a live-in situation where fellowship could be shared, and in-depth study and workshop techniques experienced. Popularity of such schools over the years has brought students and tutors from as far afield as Auckland and *Borland Lodge* has now become known throughout New Zealand.

The first school was held in January 1978. Michael Trumic and Geoff Logan tutored, concentrating on form with hand and wheel work, and texture and design for coil and slab work. Pots were fired by the raku method — with the help of an obliging rabbit the kiln was built into the side of a bank. A word from Michael — "Deep in Southland County surrounded by Beech Forest, Monawai, for me felt like the real heart of New Zealand. A most inspiring place to work with clay."

In 1979 Yvonne Rust and Kevin Griffen tutored. Kevin says "This live-in school is an excellent concept and the fact that it survives as a yearly event is indicative of its success. It is in an excellent location, being isolated — important for participants away from work, community and home pressures. Enthusiasm by the *Otautau Potters Club* members ensures its success."

In 1979 Yvonne Rust and Kevin Griffen tutored. Kevin says "This live-in school is an excellent concept and the fact that it survives as a yearly event is indicative of its success. It is in an excellent location, being isolated — important for participants away from work, community and home pressures. Enthusiasm by the *Otautau Potters Club* members ensures its success."

In 1979 Yvonne Rust and Kevin Griffen tutored. Kevin says "This live-in school is an excellent concept and the fact that it survives as a yearly event is indicative of its success. It is in an excellent location, being isolated — important for participants away from work, community and home pressures. Enthusiasm by the *Otautau Potters Club* members ensures its success."

In 1979 Yvonne Rust and Kevin Griffen tutored. Kevin says "This live-in school is an excellent concept and the fact that it survives as a yearly event is indicative of its success. It is in an excellent location, being isolated — important for participants away from work, community and home pressures. Enthusiasm by the *Otautau Potters Club* members ensures its success."

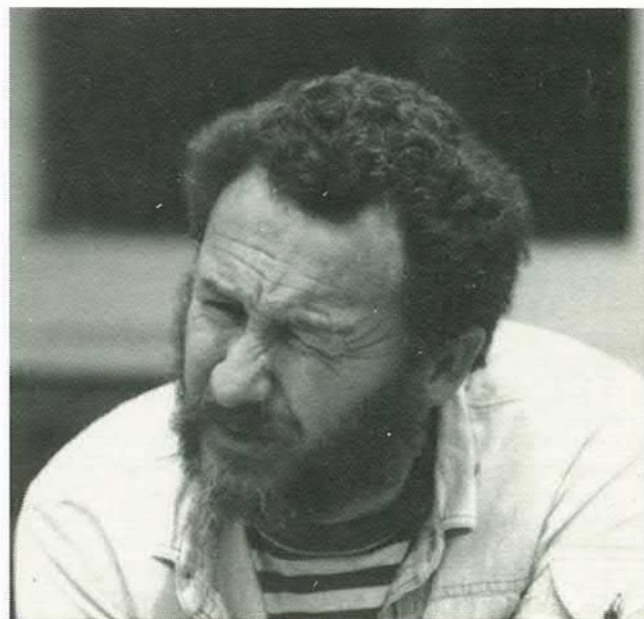

A long day is over, but much has been achieved., Chester Nealie, 1984

Brian Gartside, George Kojis and Roy Cowan tutored in 1980. A small diesel kiln was built and fired to some incredible temperatures in amazingly short times; many local materials were tested for fluxing and refractory qualities.

A water problem at *Borland Lodge* in 1981 meant that at short notice the school could not be held there. With disappointment evident, but enthusiasm high, rather than cancel, another venue was found at the Southland coastal town Riverton.

Jean Hastedt and Roy Cowan tutored at this school which proved just as successful despite the change of venue. A small diesel kiln of Cowan design was fired, with decorated stoneware followed by salt firings.

Ranfurly potter Shirley Corbishley writes, "I went to *Borland Summer School* to gain further skills in the art of potting, but found pottery was not the only activity to be enjoyed there. To live in with over 30 potters is a tremendous experience. Friends have been made of other students met during my 3 trips to *Borland* schools. To share classes, chores and social hours with top tutors and fellow students all adds to the highlights of the week. All tutors I've had at *Borland* have been of the highest calibre and have been ex-

remely generous with their knowledge and time. To ensure successful kiln firings they were willing to remain on duty far into the night and these occasions were always special as the camaraderie which developed was great. My return home always saw me a potter with higher standards and with inspiration for better work — and slightly over-weight because the cuisine is superb, thanks to members of the *Otautau Potters*."

Jean Hastedt returned as tutor in 1983 with Chester Nealie. *Enjoyment and Freedom* with clay was the theme at this school. A *Nealie* kiln was built, and fired results appeared similar to *Anagama* pots. Chester pursued his outdoor skills further than the kiln and in the crystal clear water of the *Borland* River, caught a beautiful trout which was cooked and dealt with in *Cordon Bleu* style.

Chester returned in 1984 as tutor, concentrating on wheel work relating to *Form and Function* and raw salt firings. Peter Johnson joined him, revolving his class around handwork and good clay basics. A low fired gas kiln was used with emphasis on decoration and smoking.

Peter along with Len Castle tutored the 1985 school. Len's special interest was the aesthetic character that can be



Salt glazed teapot by tutor Jean Hastedt, 1983



Chester Nealie's pots being raw glazed with "Jester's Ash", 1984

derived from clay. Many techniques for individual needs were taught. Low fired kilns were used for salt glazing as well as smoking, giving pleasing and interesting results.

January 1986 will have welcomed Len Castle and Ian Smail, ensuring all those attending a most enjoyable and beneficial week.

All students don't attend just for potting, one being Frank Checkets

who has attended 5 *Borland* schools, "The meals are my drawcard!" — but his willingness as a carpenter to erect shelters over kilns (to keep the sun out!) has always been appreciated.

To date *Otautau Club* has enjoyed hosting 8 pottery schools in conjunction with *Southland Community College* and has shared many friendships with fellow potters from all over New Zealand.

For information of the *Borland Lodge Pottery School* for 1987 contact:

The Registrar
Southland Community College
Private Bag
Invercargill

Southern ART SCHOOL
17-25 May 1986

PAINTING I - Michael Ebel
WOODTURNING - Mark Christiansen
AIRBRUSH - Allan Derrick
ETCHING - Kristeen Lockett
IKAT WEAVING - Maureen Lorimer
CREATIVE SEWING - Elen Ballantyne
POTTERY - John Crawford
PHOTOGRAPHY - Peter Feryer
LEATHERCRAFT - David Russell
PAINTING II - Paul van den Bergh
STONE & BONE - John Parker
SHADOW THEATRE - Brian & Helen
TAI CHI - Ginny Henderson
PICTURE PRESENTATION - Bob Botting
DESIGN - Michael Ebel

SOUTHLAND COMMUNITY COLLEGE

FOR DETAILS AVAILABLE FROM:
THE REGISTRAR
SOUTHLAND COMMUNITY COLLEGE
PRIVATE BAG
INVERCARGILL

COMMERCIAL MINERALS LIMITED



58 Ellice Rd
Glenfield
PO Box 2679
Auckland 1
Telephone 44 44 521

Importers of:

Ball clays
Calcined flint clays
Feldspar potash/soda
Kaolin china clays
Manganese
Silica — various grades
Talc — various grades
Wollastonite



THE FLETCHER BROWNBUILT POTTERY AWARD 1986

★ Closing Date

All entries must be in the hands of the Competition organisers by 5pm Friday 16th May 1986.

This award is being made annually to encourage excellence in ceramics in New Zealand by Fletcher Brownbuilt in association with the Auckland Studio Potters (Inc.).

★ The Work

This year each potter is invited to submit one entry for the 1986 Pottery Award. There will be no category or theme. Each entry will be judged on excellence.

★ The Award

The Judge will seek one outstanding winning entry for which an award of \$NZ5,000 cash will be made.
A limited number of Certificates of merit will be awarded at the Judge's discretion.

KILNS AND SUPPLIES FOR POTTERS



Write for catalogues and information

Cobcraft

388 MONTREAL STREET
P.O. BOX 25053 PH. 67-229
CHRISTCHURCH, NEW ZEALAND

Following extensive research on Pugmills from around the world, Winstone Potter's Clay have selected a new super-duty Pugmill to bring improved plasticity to all their clays.

The clay's plasticity has been improved as a result of a maximising of the de-airing process, which also means maximum green strength and improved crack-resistance in throwing.

But that's not all ... the new machines stainless-steel construction means no rust which minimises iron spot and bleeders in the clay, and an extra kneading and mixing device delivers a more consistent-blended, uniform product.

Plus, their convenient new 20kg pack in a strong, single plastic bag means no more staples.



Now Winstone Potters Clays have improved plasticity.

PETER LANGE AT THE POTTERS' SHOP WELLINGTON

By Anneke Borren,
Paraparaumu

Photos by Brian Davis

To celebrate the very successful running of their co-operative for two and a half years now, the *Potters' Shop* in Tinakori Road, Wellington, held their first exhibition at the end of October 1985.

They went to the *Albany Village Potters* who had given them advice at the start of their venture and chose Peter Lange, making another first, as Peter had not had a solo exhibition before. A wonderful start was made at 9am with a champagne breakfast enjoyed by all, including visitors.

The champagne bubbled inside one — as did the zany humour of Peter's slipcast pieces.

Imagine a combination of various items like concrete blocks, beer cans, nuts and bolts, dildo's, the odd wettext sponge, cakes of pink soap, half bricks, kitchen taps and pieces of wood — all acting as bedside lamps, lidded jars or teapots and all functioning well.

Reality and illusion melt together, to the extent that the eye is deceived and even touch makes it an uncertain clay connection.

To make moulds of all these objects, slipcast and assemble, colour with stains and oxides, glaze and fire (to about 1150°C) requires a lot of experimentation, expertise and cheek, extending the edge of reality by technical knowledge and wittiness, affording limitless possibilities, but still retaining the essential quality of clay, as appreciated by the tactile senses.

As I surveyed the 22 pieces, each exhibiting a compatible sense of humour, what came through was a very personal statement in clay; in New Zealand a valid, but still mostly unused play with existing values in clay. Peter has played here, showing definite strengths and tensions, with at times, political overtones.

A memorable first exhibition.

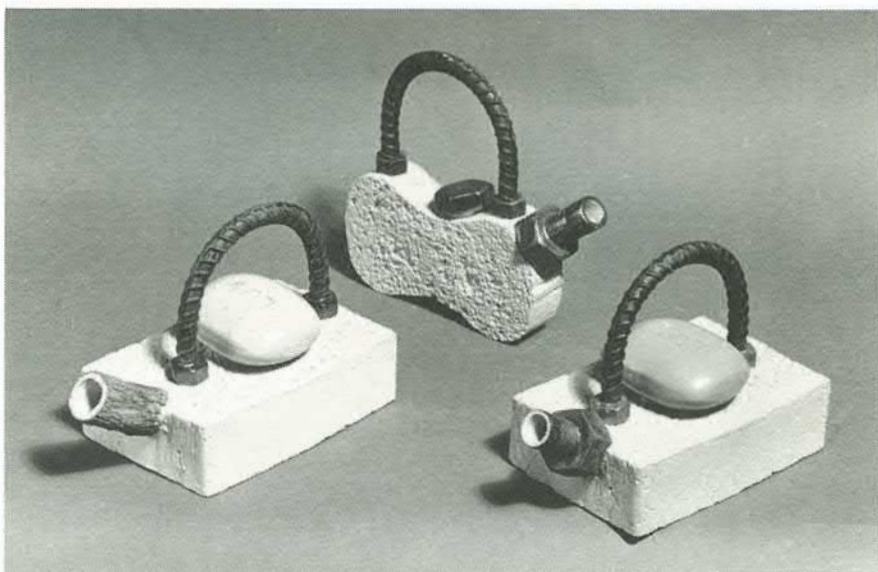

See also colour photo page 45



NEW ZEALAND POTTER No.1, 1986

BOB SHAY MAKES ART IN NZ

By Howard S Williams

Photos by Elaine Comer

Robert Shay and his wife Elaine Comer live and work in Columbus, Ohio, where he is also an associate professor of art at the *Ohio State University*. He has been brought to New Zealand by the *NZ Crafts Council* and the *Wellington City Art Gallery*, to be Artist in Residence during the *NZ International Festival of the Arts*, this March in Wellington. His ceramic art was on show at the *Wellington City Art Gallery*, and the pieces he has made during his workshop here will return with him to be exhibited in the States. Bob has also toured much of this country giving slide showings and taking demonstration workshops for many of the pottery societies.

With his infectious enthusiasm and willingness to share of his vast knowledge, Bob will have left an indelible impression on many of our potters; our exhibitions will never quite be the same again — not after the introduction of *Otto's Red* glaze!

Otto Natzler Red	
1015°C, oxidation	
(Crackles like crazy)	
White or red lead	62.1
Potash felspar	20
Barium carbonate	9.5
China clay	4.2
Cornish stone	4.2
Chrome oxide	8

N.B. As everyone knows, lead is a dangerous material to use, so if you make up this glaze be certain to take all precautions. Do not breathe in any dust, do not smoke or eat while working, wash hands and all surfaces after use. Keep your lead safely packaged and out of reach of children. This glaze is stunningly colourful and textural for use on sculptural pieces — not on pots for food use.

The white or red lead can be replaced by lead bisilicate, increasing the amount by 10%. This makes a safer glaze to handle. Different colours can be obtained by replacing the chrome oxide with experimental amounts of other oxides. The glaze can be applied very thickly for heavier textures.

For other exciting glazes see the recipe chart. These are dry, matt glazes for use on sculptural ceramics and have a wide firing range centred on 1015°C in an oxidation atmosphere.

The clear glaze Bob uses with these is:

Gerstley borate	80
Nepheline Syenite	20

Many of Bob Shay's ceramics are doubled-walled slip cast shapes, but often he will use his moulds to press solid clay shapes, which after firing will have hot molten glass poured into them. (See cover photo, and "Vessels"). The fired clay may be cold at the time of pouring the glass, so it must be able to withstand great thermal shock. His clay is very short, has 10% shrinkage overall, and fires to 1200°C. It is made of equal parts by volume of:

Ball clay	Perlite
Talc	Sawdust
Fire clay	Grog

The grog is made from ground-up soft insulating bricks; Perlite is expanded volcanic ash, bought in the form of small pellets from a garden centre.

His white earthenware casting slip, firing between 1000°C and 1100°C in oxidation, is as follows (and I leave you to do your own quantity conversion):

To 6 USA quarts of hot water add 3 level teaspoons of sodium bicarbonate, and 5 level tablespoons of thick sodium silicate. (140° twaddle). Mix these together and then add — gradually, while stirring — 6 USA quarts of powdered white ball clay, followed by 6 USA quarts of talc. Allow it to mature for a few days, then stir and put through an 80 mesh sieve before casting.

"Vessel" slipcast, multiple fired, under and over glaze. 80 cms long, 22 cms wide



Multi-firing is another of Bob's specialties — he keeps refiring until he catches a particular desired effect, often lowering the temperature each time as he adds lower maturing glazes, down to enamels and lustres.

A double-wall slip cast vessel will first be saggar fired to any old temperature, as long as it is bisqued. The vessel will be partly buried in the saggar, in vermiculite, bits of copper wire, copper oxide, copper carbonate and perhaps a couple of rock salt crystals.

The second firing, after applying commercial earthenware glazes in specific areas, with brushes and masking tape, goes to 1100°C in oxidation. Most of the saggar fired marks remain intact. The third firing is the same, after perhaps adding more glaze colours, or an overall clear glaze as in the recipe already given.

The fourth firing will be taken to 700°C, to fire on metallic lustres which were brushed onto the clear glaze. The kiln must be well ventilated (leave all bungs out) during the initial part of this firing to allow the oil medium in the lustres to be driven off.

The fifth firing is after the application of commercial overglazes which are glycerine based (*Harrison Mayer, Degussa*). This is also taken to 700°C.

Then, perhaps hot glass is poured into the form, or the whole thing is sandblasted. The art is in where one puts all this colour and texture. And in knowing when to stop.

Bob Shay has lots of fun — and makes art.

Have fun!

NEW ZEALAND POTTER No.1, 1986



"Vessel" solid press-moulded clay, saggar fired in vermiculite. Hot glass poured in after firing
 Photos, including cover photo by Elaine Comer



"Vessel" solid clay with poured glass

Detail of glass in "Vessel". See also cover photo



"Core Sample" floor piece, 60 cms long, 23 cms diam, glass core 7.5 cms diam.

Cut through with diamond saw

Detail, face of floor piece, "Core Sample"



BOB SHAY'S GLAZE RECIPE CHART

	CONE 06 1015°C OXIDATION MATT. TEXTURE WIDE TEMPERATURE RANGE	MAGNESIUM CARBONATE	KAOLIN	LITHIUM CARBONATE	BORAX	GERSTLEY BORATE	COPPER CARBONATE	SILICA	BENTONITE	RUTILE	IRON OXIDE	COBALT CARBONATE	COBALT OXIDE	BALL CLAY	TALC	MANGANESE DIOXIDE	ZIRCO-PAX	NEPHELINE SYENITE	CHROME OXIDE	WHITING
A	LICHENS	50		10	50	30	4					0.4								
B	LIZARD	40		15	10	70		5										20	0.4	
C	FLAMEDROPS	40		20		70	6													0.3
D	MOON	50	20	10	40	20	10													
E	CRATERS	20	20	60	30		12	60	10											
F	BEADS	50			40	50		10									10			
G	CARBON	30			80	60				30	40		7							
H	EARTHMOTHER			30		30	3	20				1		10	10	3				
I	OCEAN OIL		10	30	20	40	6													40
J	SUPERSTITION			30		40	3						0.5		30			10		

ROBERT SHAY U.S.A. ARTIST IN RESIDENCE EXHIBITION



WELLINGTON CITY GALLERY
 MARCH — APRIL 1986

* test has too much Copper Carb

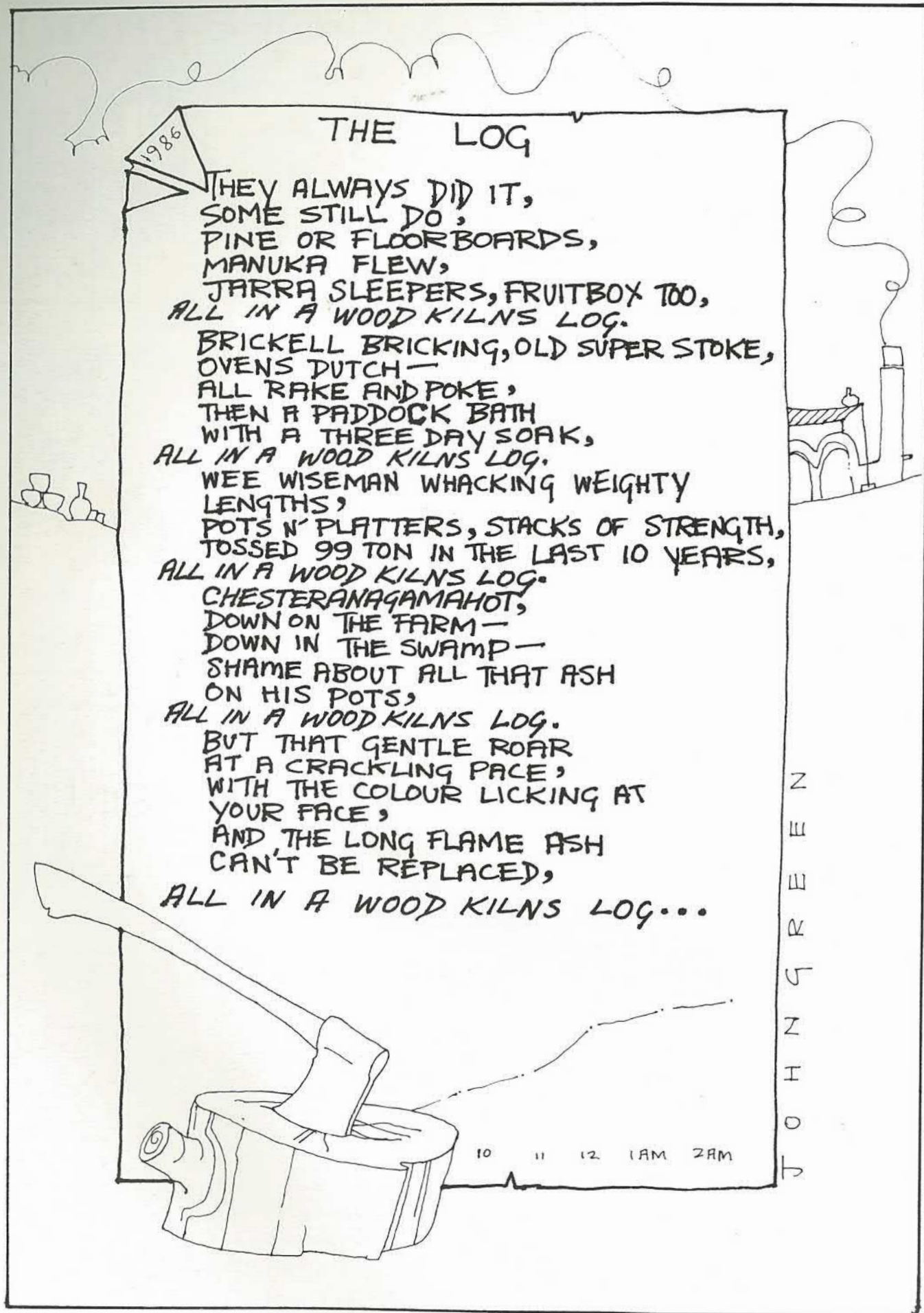

MURRAY CLAYTON — CLAYPOTS

By Daphne Hendrie, Wellington

Photos by Julie Obren

In the hilly terrain of the Ohariu Valley, some 20 minutes drive from Wellington city, I found Murray Clayton in the midst of a pit firing with a group of potters. Between stokings I managed to snatch him away briefly to discover how he has become one of Wellington's leading production potters.

Murray's studio is adjacent to his home and aptly named *Claypots*. Although he has been potting seriously for 5½ years, his introduction to clay began in 1970. He had just gained a degree in architecture and was working alongside David Brokenshire who first fostered his interest in clay. He then attended night classes in Tauranga for 18 months before setting off to England, where he enrolled at the *Sir John Cass School of Art* in London.

This turned out to be less than anticipated as his tutor, after 3 months, was replaced by a slipcaster. This approach held no interest for him, so back to *Godzone* briefly, then off to Papua New Guinea as an architect. His spare time aim was to 'dabble' in clay as much as possible. He had his *Leach* wheel shipped across, dug his own clay and built a kiln, albeit crude, to fire his pots. This is when he decided potting would be his vocation.

On returning to New Zealand, his wife Carol became the breadwinner while Murray began the awesome task of setting up his pottery. First in Wadestown, then two years ago at their present home in the Valley, which has now become a tourist stop for buyers of fine pots.

His pots range from all sizes of finely thrown bowls, teapots, coffee mugs and planters, to large slab constructions including fountains. Murray works mainly in stoneware although he has just begun to experiment with porcelain. He fires in a 26 cu ft LPG kiln and a normal potting day is from 5.30am to 2.30pm, including weekends. Like most potters Murray has his spells of high production, spells of pot design and experimenting, and spells of doing nothing — if you can call keeping his 5 acre property and garden immaculate, doing nothing. Murray is in the *Potters Shop* co-operative in the city and an active member of the *Wellington Potters Association*.

Probably Murray's architectural training has influenced his style as he was taught that form follows function, hence the lack of detailed embellishment on most of his work.

Murray's statement personifies the man. "I am a functional potter who likes making pots that find a way to be used in peoples' homes."



Murray Clayton in his workshop 'Claypots'



"CANTERBURY '86"

Further news on the NZSP convention, Christchurch, 16th to 18th May, 1986

Our Australian guest, Janet Mansfield and Nelson's Royce McGlashen will be combining to talk about their time in, and impressions of the U.S. of A.

The Halswell Pottery Group headed by Veda Milligan has already been transforming clay into delightful, whimsical, colourful and melodic whistles. These creations will spur others on in the whistle workshop.

A separate all day session by the principals of Rexmark Kilns has been organised for the Monday immediately following the convention. This is being arranged under the auspices of the Canterbury Potters' Association and will be held in their studios in the Christchurch Arts Centre. This demonstration/seminar will deal with all aspects of LPG kilns, firing techniques included.

Mrs Iwako Graham, formerly of Osaka, Japan will be giving a demonstration of brush work and calligraphy. Mrs Graham has studied calligraphy and poetry for 40 years and has won the Mainichi Prize for Calligraphy 12 times.

Registration forms for "Canterbury '86" are now available from:

The Organising Committee
"Canterbury '86"
PO Box 29-208
Christchurch.

NB: You do not have to be a member of the NZ Society of Potters in order to attend most of the functions at this conference.

Salt glazed pot by Janet Mansfield
Guest potter from Australia.

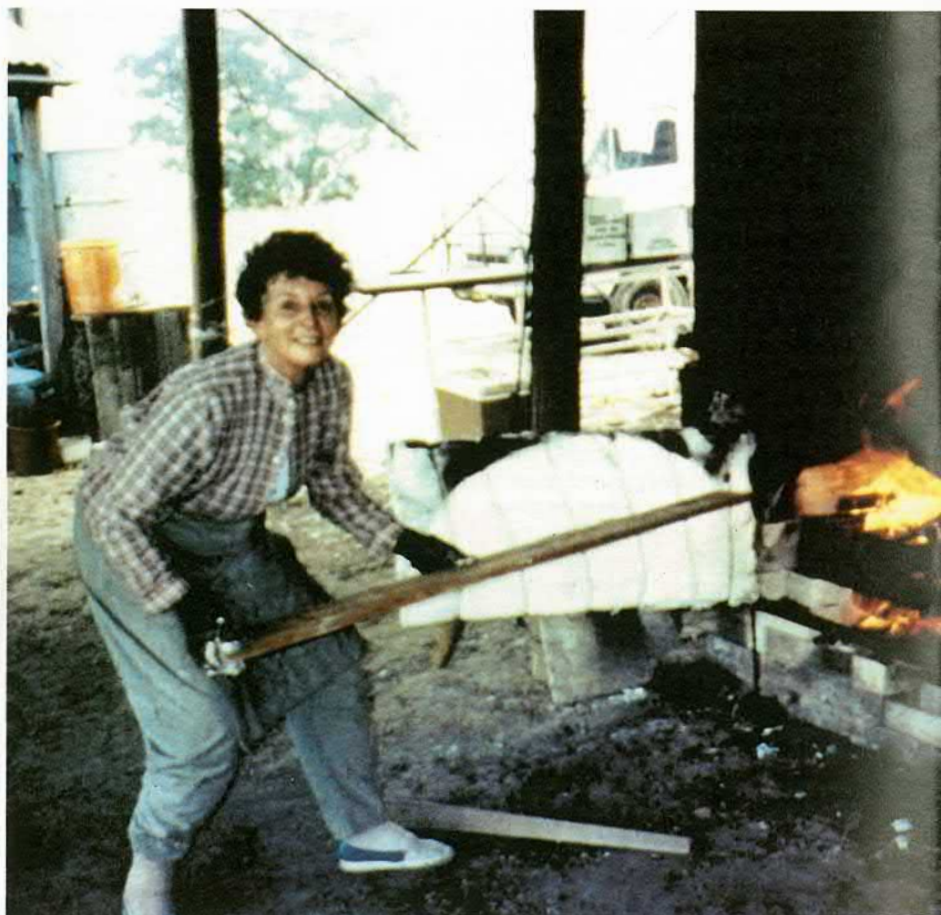
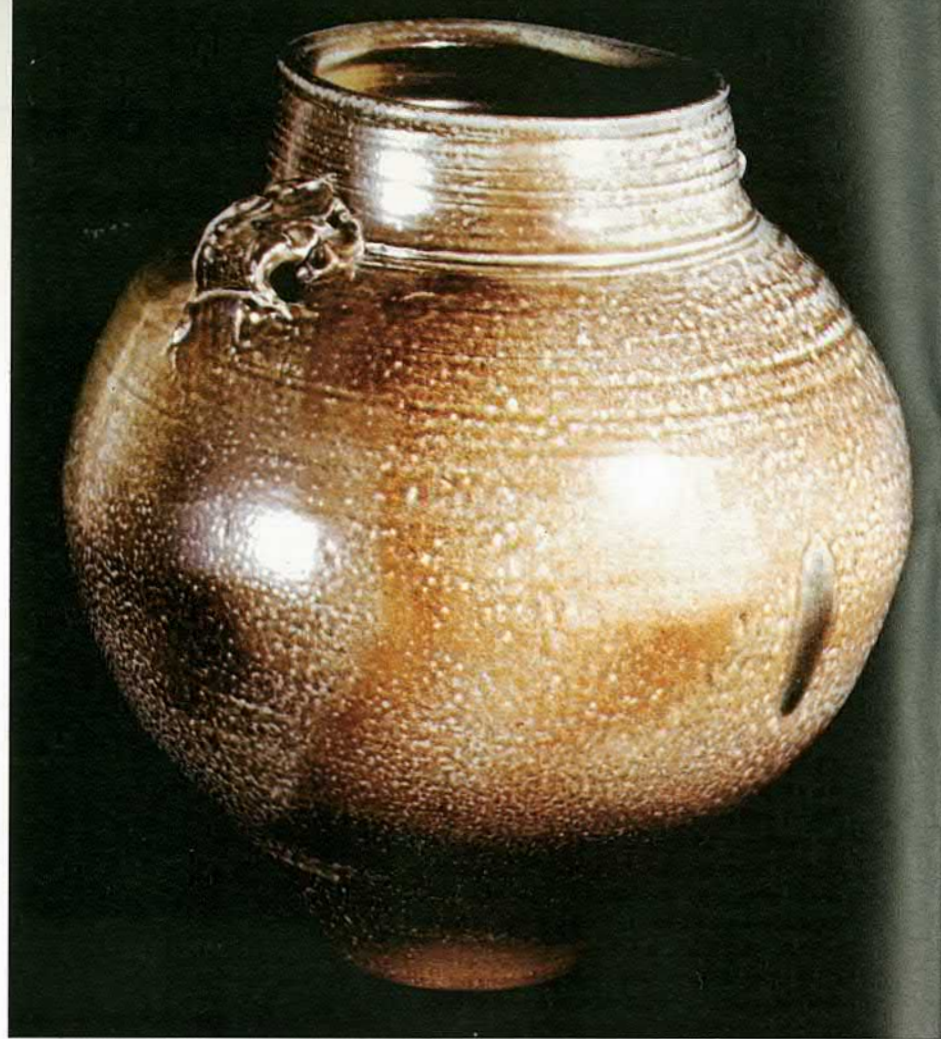

WAIKATO SOCIETY OF POTTERS

A Unique Workshop Facility

By Don McArthur,
President WSP, Hamilton

The Waikato Society of Potters was formed in 1972 and since then has annually organised schools and exhibitions at various venues in Hamilton. By 1981 moves were afoot for the society to obtain its own workshop. At times it appeared that the society would never have its own home, as finances precluded being able to purchase a property and rental costs were very high. During this frustrating period the Hamilton City Council were very helpful and endeavoured to assist.

In 1983 an approach was made to the society by three theatre groups to join with them. They had persuaded the Hamilton City Council to purchase an old Cabaret building and lease it to them. The council had mentioned that the potters were also looking for a workshop and the theatre groups agreed that part of the complex could be suitable for this purpose.

In October 1983, after much ground work, a Special General Meeting was called and despite reservations from many members it was resolved that the society join with the theatre groups in the venture. Shortly after, one of the theatre groups pulled out, leaving Waikato Society of Potters, Musicians and Playbox Repertory to form the Riverlea Theatre and Arts Centre Trust, which now comprises 5 members from each group, plus 4 other elected specialist members. To obtain a cash flow, it was agreed that the theatre complex had to receive priority. Despite many hassles bringing the building up to standard, this was done by December 1983, although all necessary permits and licences were not obtained by the time of the first performances. These were obtained only 3 days before the official opening by Sir Michael Fowler in May 1984.



Main entrance to WSP workshop. Wall mural painted by a Periodic Detention worker

Work was proceeding on the pottery area, although it wasn't until the following November that electricity was connected.

The workshop area is 2,000 sq ft, plus a kiln and drying room of 330 sq ft and a storage area of 600 sq ft.

At the time the WSP agreed to the venture, assets owned were negligible, but now there is over \$28,000 worth of equipment in the workshop. This includes 20 new electric wheels with individual work tables, a slab roller and a 5 cu ft electric kiln. An 11 cu ft natural gas kiln is on order and a woodfired kiln is to be constructed soon.

Considerable financial assistance has been given by the Hamilton City Council Community Arts Programme and the Northern Regional Arts Council, and in addition much of their equipment has been donated from various sources.

As the WSP's activities are not generally revenue earning, it was agreed that the rental for the potters be based on usage, the charge being 75c per person per session. In addition the workshop is separately metered for electricity. Club day and evening fees are set at \$1 per person per session, which gives members

Photos by Mike Todd

WSP's pottery collection



good facilities and good company at a nominal charge. Kiln charges are additional.

The grounds are extensive and include mature trees. A large pit kiln has been dug and is regularly fired. On most Saturdays a team of up to 10 periodic detention workers are sent to the Riverlea Centre by the Justice Department. These workers maintain the grounds and do any other work, such as painting, that is required by any of the groups. This service means that members of the groups are not regularly committed to maintenance work and the monetary saving is considerable.

The extent of the grounds available make it an ideal setting for Pottery Open Days which are held twice a year. At these there are demonstrations, sales tables, barbecues, raku firings and other activities which have attracted large public attendances.

The theatre side of the complex also involves volunteers from the pottery group. The Trust has been successful in obtaining a liquor licence and the large kitchen area is run by a commercial caterer, who is also an active member of the theatre group. Theatre shows can include dinner, when members of all groups assist as waitresses, kitchen hands, wine stewards or barpersons.

The interlocking of the groups is further enhanced with regular combined club nights on any Friday that there is no show running — bus trips and barbecues. In the long term it is anticipated that virtually all costs associated with the complex will be met from the liquor licence.

Several display cabinets have been installed in the theatre foyer and different potters are invited to display pottery during performances. The displays are normally changed for each show and where possible they compliment that particular show.

This year the Waikato Society of Potters is joining with the Waikato Technical Institute in a combined programme of classes, weekend schools and other activities. To avoid competition it was felt that amalgamation in this area would enhance available facilities for the benefit of all. Some activities will be held in the WTI workshop, others at the WSP Riverlea workshop.

Whilst there have been teething problems in assimilating the groups, who have differing ideas and needs, the co-operation now shown makes this a unique facility in the arts and crafts scene in New Zealand.



Main pottery workshop



Kiln and drying room



Photos by Val McArthur, of activities on WSP Open Day



This photograph won the Silver Merit Award in the NZ Professional Photographers Assn. National Print Exhibition 1985. The photograph was by Richard Poole, Christchurch. The pot which he used as his subject is a handbuilt stoneware wall vase by Coyla Radcliffe-Oliver, Christchurch.

DESIGN IN SCANDINAVIA

The Danish Cultural Institute has arranged a study tour of Finland, Sweden, Norway and Denmark, 24 August to 6 September, 1986. The course will be conducted by a Danish architect John Vedel-Rieper who is currently Secretary General of the World Crafts Council. There will be lectures, visits to workshops, factories and exhibitions, and opportunity to meet many Scandinavian craftspeople and designers. Details are available from:

Knud Lindum Poulsen
Det danske Selskab
Kulturvet 2, DK — 1175
Copenhagen K
Denmark.

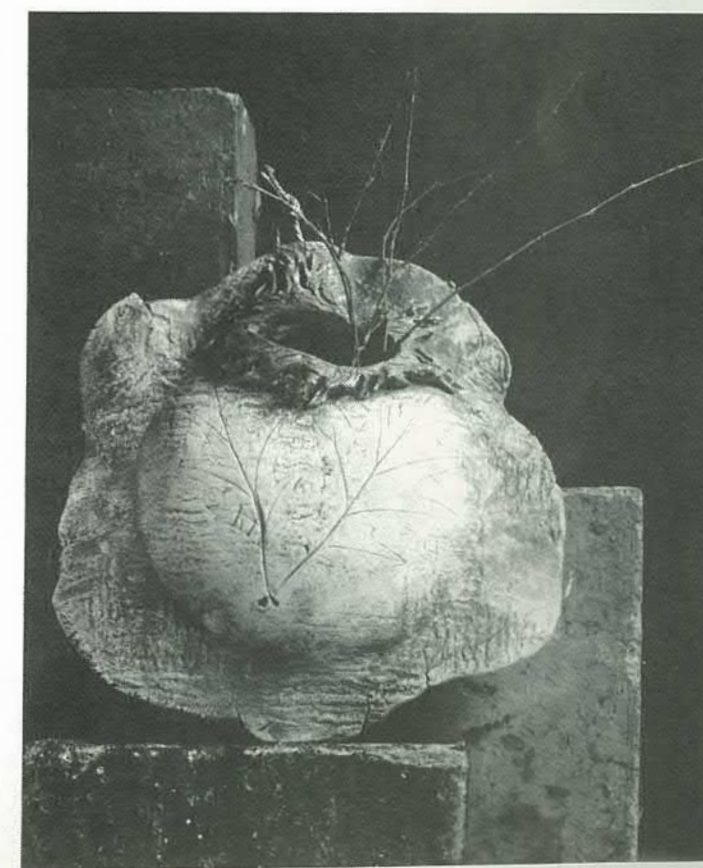

WAIKATO SOCIETY OF POTTERS

Waikato Museum of Art and History

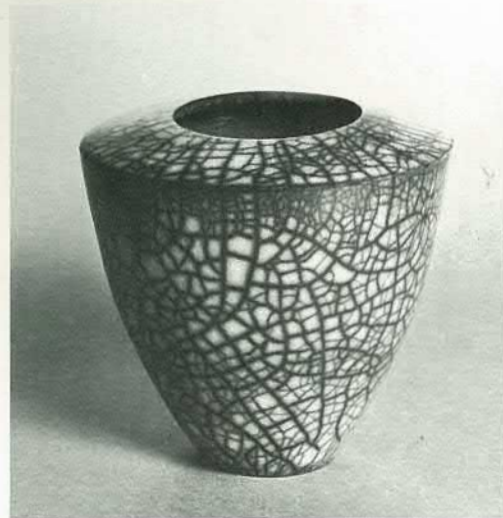

Sue Knowles: raku cone form

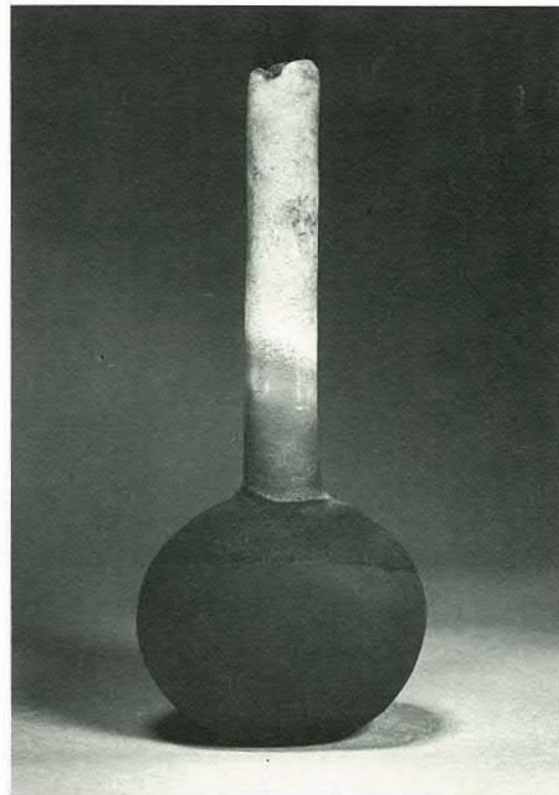

Don Thornley: raku bottle

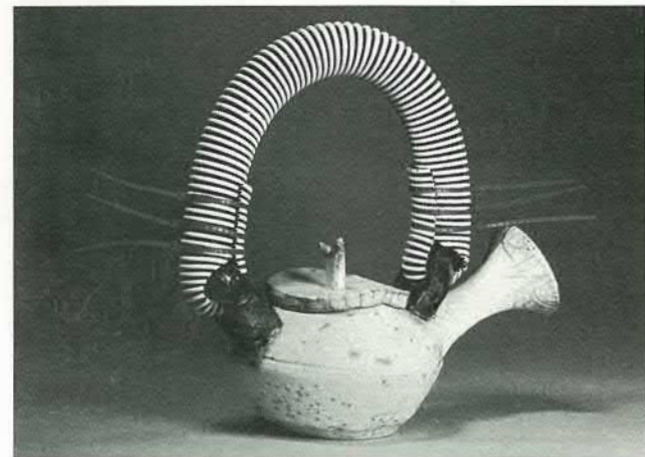

Gary Nevin: raku teapot

Joan Lamberton: copper red stoneware branch pot

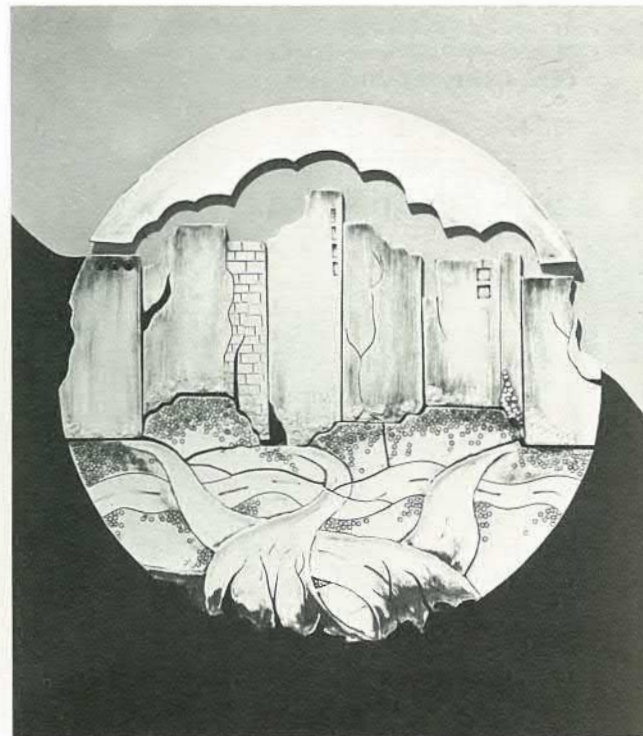

Kerry McConnell: porcelain wall panel

13TH ANNUAL EXHIBITION

October 1985, Selector: Len Castle

Photos by Keith Sprengers

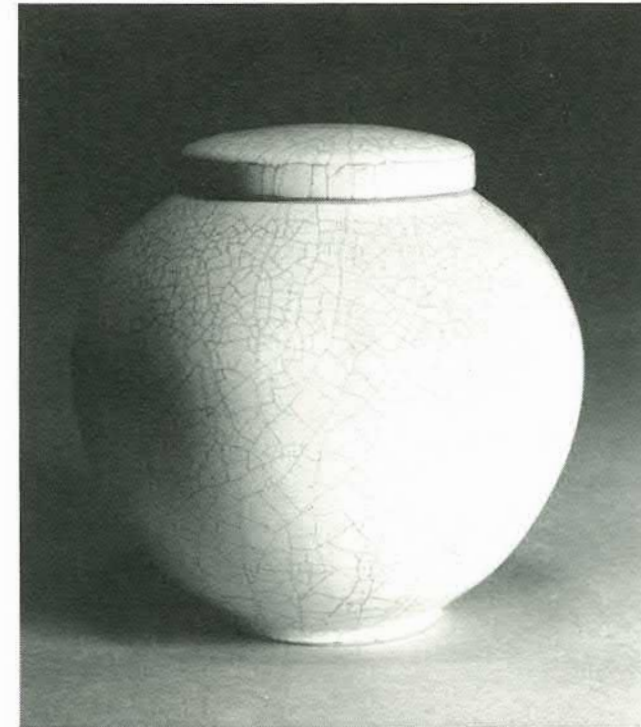

Verna Beech: stoneware ginger jar

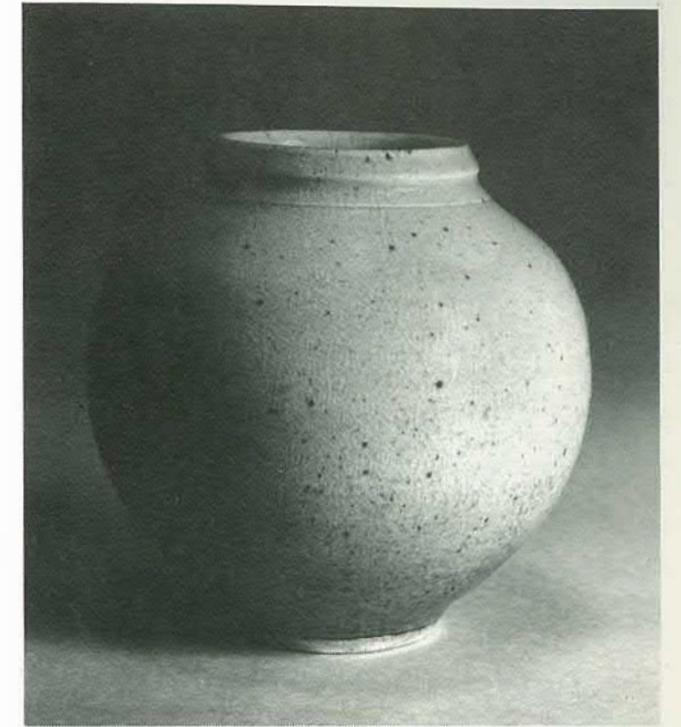

Malvai Hoole: stoneware celadon blossom bowl

Nicky Jolly: raku bronzed pot



Raewyn Atkinson: woodfired stoneware teapot

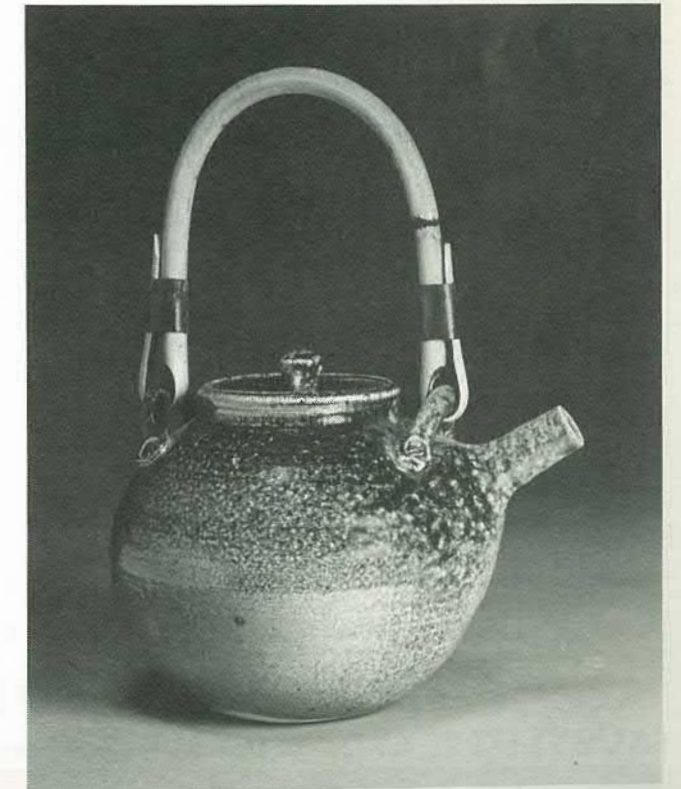

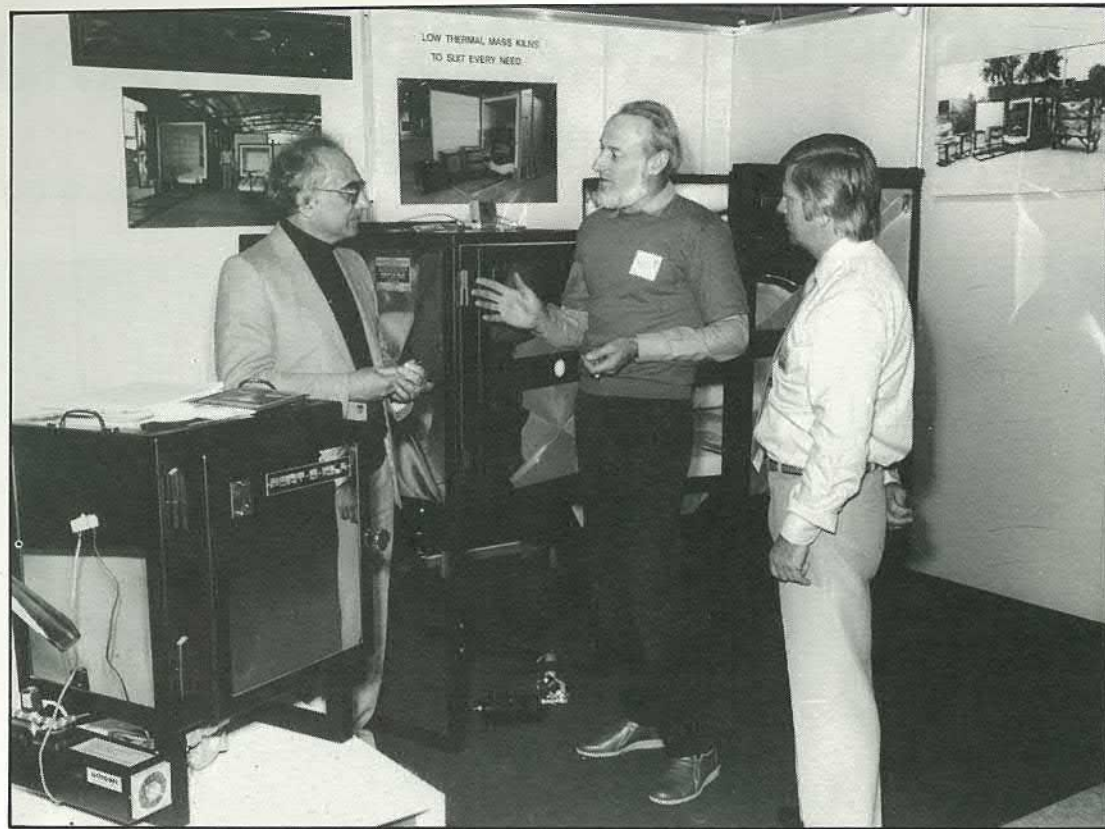

The editor of the NZ POTTER, Howard Williams discusses the PORTOKILN range of gas-fired kilns at the NZ International Trade Fair in Auckland. With him is the managing director of PORTOKILN (Aust) Pty Ltd, Joe Davis, left and his partner Allan Clarke, right. Photo by J & J Farrelly.



From left to right: China Painter; Model 2000 Ceramics Kiln; Chameleon (approx. 2 c.f. Stoneware Kiln) Model 40 (Stoneware); Model 80 (Stoneware); 72 c.f. trolley; 18 c.f. model.

Quality, High Technology Kilns need not cost an arm and a leg!

Extracts from the independent expert panel assessment for the 1984 AUSTRALIAN DESIGN AWARD RECEIVED BY PORT-O-KILN (Complete Panel Assessment available on request.

"The latest range of kilns reflect Port-O-Kiln's policy of ongoing product improvement ... The Panel commended the Manufacturer on the high quality of the construction of his products ... Port-O-Kiln has increased fuel efficiency through its use of a minimum brickwork floor ... High quality stainless steel panels ... Manufacturer particularly concerned to maximise safety features and simplify operation of the kilns ... Standard gas train for L.P. Gas fully approved by both the Victorian and N.S.W. Government Safety Authorities ... Through the innovative use of new technology, the Manufacturer has been able to develop a kiln which satisfies the potter's requirements ... The kilns represent excellent value for money ..."

A PORT-O-KILN TO SUIT YOUR REQUIREMENTS COULD BE MUCH CHEAPER THAN YOU THINK ... IN FACT, IT MAY BE COSTING YOU MORE NOT TO BUY ONE!!

PORT-O-KILN

(AUST) PTY. LTD. 26 Brooklyn Ave. Dandenong Victoria, Australia Phone: (03) 791 6799

Many years ago, Strath McKnight, when he was a radio electrician built an electric kiln, and probably the first electric wheel in Christchurch, for his wife Julie, then a fascinated amateur potter. Ten years of work saw Julie's pots being sold all round the world in such numbers that they formed a small factory, J.K. Potteries in Woolston, Christchurch, in order to supply the demand.

Strath and Julie are also well known in the area as radio personalities, and have both featured in TV commercials. Though now retired, they are still very active in the pottery field.

Photos show some recent slip cast work from J.K. Potteries.



Have you a potter as a friend? Or do you enjoy reading about New Zealand potting at its best? A subscription to New Zealand's potting magazine makes a wonderful gift.



NEW ZEALAND POTTER, PRIVATE BAG, PETONE.

I enclose my cheque for \$15 for 3 issues
If this subscription is a gift, please fill in YOUR name and address here and the recipient's below.....

NAME

ADDRESS

**Robert McDougall
ART GALLERY**

Christchurch City Council
Botanic Gardens
Christchurch

NZ FINE ARTS

10am to 4.30pm Daily

ANCIENT POTS AND POTTERS

By Alison Holcroft, Kaiapoi.

Photos by Michael Holcroft, courtesy of the University of Canterbury

Not many potters would expect to have their pots still around several thousand years after they were made. We tend to think of pottery as a rather fragile medium. In fact fired clay, like concrete, is virtually indestructible. Even if broken into hundreds of fragments — a fate that has befallen more than one ancient pot — it can still be reassembled and appreciated in something very close to its original form. Pottery that survives unbroken retains its original colour and lustre to a greater extent than almost any other fabric.

Over the summer the Robert McDougall Art Gallery in Christchurch has been showing a representative selection of Cypriot and Greek pottery made between 2000 B.C. and 300 B.C. These pots come from the University of Canterbury's Logie Collection and are on full public display for the first time in New Zealand. The *Ancient Celebrations* exhibition is an eye opener for potters.

The oldest pots in the exhibition were made in Cyprus in the early Bronze Age, about 4000 years ago. These pots, grouped together in the first room of the exhibition, all come from the same tomb at Lapsata in northern Cyprus. They have survived virtually intact because of the Cypriot custom of placing the dead in chamber tombs hollowed out of the rock together with a set of domestic utensils for use in the after life.

The Cypriot pots are quite different from others in the exhibition. Their shapes — in particular the long-necked pitcher and the breast-shaped bowls — have little in common with the wheel-thrown Greek pots. Their plain, burnished red surfaces made an even sharper contrast with the copious painted decoration of the Greek vases.

The star of this group is the basket-shaped storage box, *pyxis* with its incised decoration and moulded figures around the opening. Unlike the plainer pieces this elaborate *pyxis* was probably made especially for funerary use. The figures around the opening — a miniature pitcher at each side and a woman at each end — are similar to those found on cult objects in other tombs of the same period.



Curators Alison Holcroft and Regina Haggo admire the 6th century Eye Cup at the "Ancient Celebrations" exhibition in the McDougall Art Gallery, Christchurch

Cypriot "Pyxis", 25 cm high: c. 2000 B.C.



The bulk of the pots in the exhibition come from the Greek world and, in particular, from Corinth and Athens. In antiquity both these cities were renowned for their production of pottery. While Athens produced the first master potters in the 8th century B.C. it was Corinth, the busy merchant city on the isthmus, that first undertook the large scale production of pottery for export. In the 7th century B.C. Corinth dominated the pottery trade. Even today Corinthian pottery turns up in archaeological excavations all over the Mediterranean, from Spain in the west to the coast of Syria and the shores of the Black Sea in the east.

Corinthian pots are distinguished by their fine, buff-coloured clay. In their heyday Corinthian potters specialized in small pots decorated with cheerful designs in black, red and white. The most typical Corinthian products are the oil flasks known as *aryballoi* and *alabastra*. These tiny vases — normally somewhere between 6 and 8 cm high — held precisely the amount of the scented cosmetic oil that was needed for a complete rub-down of the body after strenuous exercise. To make them portable they were designed to be suspended on a leather thong and worn around the wrist. (The two types of shape are distinguished by their bodies. The *aryballos* has a spherical body, the *alabastron* an ovoid one.)

Corinthian "Alabastron", 7.5 cm high: 625-600 B.C.



Aryballoi and *alabastra* were produced in vast numbers and seem to have had a rather low life expectancy. Broken *aryballoi* are some of the commonest objects in ancient Greek rubbish pits. Their decoration was often hasty and slipshod. Painters aimed for immediate visual appeal with the result that many *aryballoi* look fine at a distance, but distinctly shabby close up. All too often the paint is blotchy and the incision used for the details decidedly careless.

In some cases, however, the decoration is absolutely exquisite. There's one of this category in the exhibition, a little *alabastron* decorated with a pair of cocks contemplating a snake. At this time cocks and hens were fairly recent imports into the Greek world from the east. They were valued for their glowing plumage and their exotic Persian connections rather than their food potential. On this pot the animals' silhouettes have been painted and the details incised with loving care. The results puts this little *alabastron* in a class with the finest pottery produced in Corinth.

At Athens a major export industry in pottery developed somewhat later. Towards the end of the 7th century B.C. Athenian potters began to take over first the decorative techniques and motifs of the Corinthian workshops and then their markets. Once again it's the clay that distinguishes Athenian pottery from other wares.

Athenian potters had access to large quantities of high quality clay. In some cases they took their clay from pits that are still being worked today — like those at Amarousi, near Athens. This clay is a secondary clay containing high amounts of iron. Under normal oxidising conditions it fires to a reddish-brown colour but, with special treatment, it can be persuaded to produce a glossy black finish.

Black figure "Amphora", 42.4 cm high: c. 550 B.C. In this case the figure scene has a mythological subject. It depicts Herakles slaying the three-bodied monster Geryon.

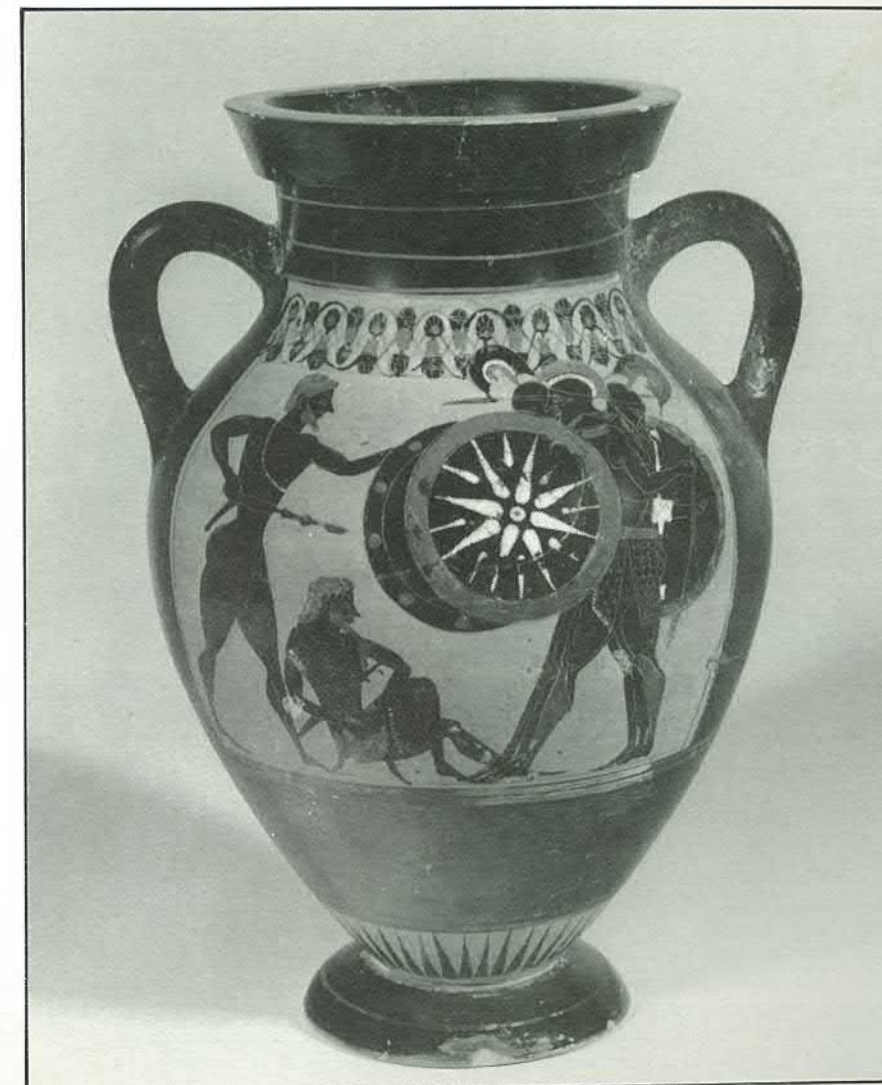

The basic techniques for firing iron clay to produce both red and black on the same pot were already well known. As early as the third millennium B.C., Egyptian potters had discovered that, by half burying their pots in a deep layer of sand during firing, they could produce pieces with red bodies and black necks. The Athenian potters took over this ancient technique and refined it to produce the highly decorated black and red wares which are the hall mark of Athenian pottery.

The process developed by Athenian potters was a complex one. The pots were formed and allowed to harden. They were then decorated with a fine slip produced from the same clay. Both the body of the vase and the slip contained considerable amounts of red ferric oxide (Fe_2O_3). Once the slip had dried the vase was put through a threefold firing.

It was first fired under oxidising conditions which left the whole vase, both fabric and slip, a reddish colour. At the end of this first stage the kiln's air vent was closed and the vase was fired again to temperatures reaching $950^{\circ}C$. During this phase the carbon monoxide (CO) produced by incomplete burning of wet wood in the kiln "robbed" oxygen from the ferric oxide in the vase and turned it into black ferrous oxide (FeO) and the even darker magnetic oxide of iron (Fe_3O_4). At the end of this stage of the firing the whole vase was black and the slip had become partly sintered.

The third phase of firing produced the characteristic combination of glossy black and matt red. The air vent was opened and oxygen re-entered the kiln to unite with the black oxides and turn them back into the red ferric oxide (Fe_2O_3). This happened easily on the coarser clay in the fabric of the vase, but the oxides in the slip had become encased in a thin layer of quartz crystals and could no longer absorb oxygen. For this reason the area painted with the slip remained black and shiny.

The red and black vases produced by this process allowed the Athenian pottery workshops to dominate the pottery trade for two hundred years. During this period the Athenian potters developed two distinct techniques for decorating their vases — black figure and red figure.

Black figure was the earlier of the two techniques. It involved painting figures on the pot using fine slip and then, once the slip had dried, adding small amounts of red and white engobes for additional decoration and incising the required detail. The end result, after firing, was a solid black silhouette modified by incision and

the use of added colour. The black figure technique with its often lavish use of incision has much in common with metal engraving techniques and similar instruments were probably used.

The red figure technique was developed in the last two decades of the 6th century B.C. It was much closer to painting than the black figure technique. On red figure vases the background was painted in with fine slip to leave the figures as unpainted silhouettes. Details were then painted in with either relief lines (in full strength slip) or matt lines (in diluted slip). The end result of this technique was a reserved silhouette modified by painted detail.

In both techniques the decoration was quite literally fired on to the surface of the vase. It was therefore highly durable. Even today, two and a half thousand years later, many black figure and red figure vases look astonishingly fresh, with their figure scenes as sharp and clear as the day they

came out of the kiln. The figure scenes, with their subject matter drawn from Greek mythology and daily life, are an important source of knowledge about the ancient world.

In spite of their experimentation with techniques and their prolific output, Athenian potters adhered to a relatively limited range of vase shapes. They preferred to refine established shapes rather than to develop new ones.

Most of the decorated black figure and red figure wares were produced for use at the *symposia* (literally "drinking parties") that formed the basis of Greek social life. The commonest shapes associated with the *symposium* were the two-handled wine jar known as the *amphora*, the large bowl for mixing wine and water *krater*, the small wine jug *oinochoe* for serving the wine and water mix and the broad-bowled drinking cup used by the individual *symposiast*.

Black Figure "Amphora", 43.5 cm high: 550-525 B.C.
The scene shows a wedding procession

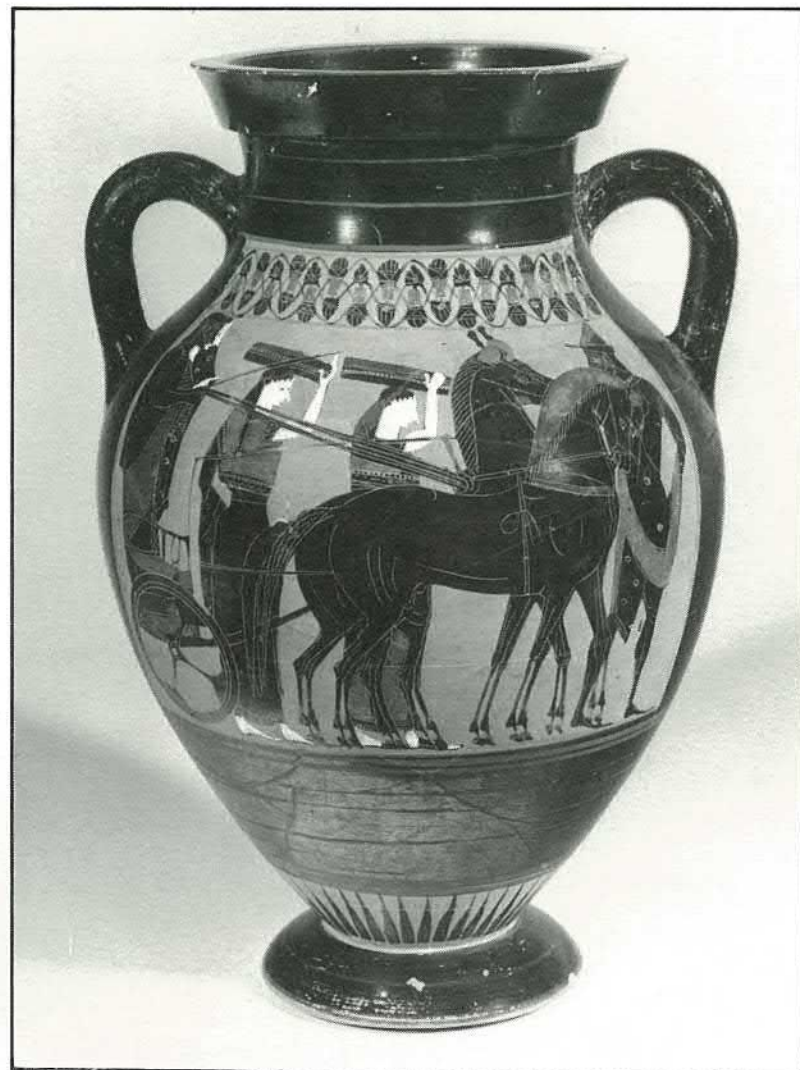

The drinking cups — there are nine of them in the exhibition — are the most typically Greek of all the *symposium* vases. The shape seems unconventional to modern eyes and even unsuited to its purpose. In fact the cups are light in weight and very easy to hold. More important, they can be held in a number of different ways — by the handles, with both hands under the bowl, by the stem or with one hand under the foot. These cups are designed to be held securely by drinkers who had already had more than enough!

They were also made for fun and the decoration reflects this. In some cases the decoration inside the bowl of the cup was designed to simulate movement under liquid — a running man with his limbs contorted into a swastika shape, a long-necked bird

with wings outspread, an embracing couple, a *symposiast* waving his arm in time to music. Other painters concentrated on the exteriors of their cups. On one cup two tiny men chase two equally tiny centaurs around the lip while below them an inscription on each side of the bowl bids fellow drinkers to "Be welcome and have a good drink!" Another cup was decorated with large impertinent eyes which combined with its handles and stem to form a staring face when it was picked up and tilted for drinking.

Italian potters are represented in the final two sections of the exhibition. The first group consists of pots made by Etruscan potters to compete with the wares imported from Corinth, Athens and the Aegean. The second group is made up of pieces produced in the wealthy Greek settlements

of southern Italy. The Etruscan and South Italian potters seem to have used a greater variety of shapes and techniques than the potters of mainland Greece. A striking piece in the Etruscan section is a dark grey *bucchero* goblet with stamped decoration. In the Italian section the most spectacular object is a massive volute handled *krater* which stands nearly a metre tall. This was made for funerary use and the poor quality of the decoration on the reverse shows that it was designed to be seen only from the front.

The fifty items in the exhibition give a fascinating insight into the world of antiquity. Through the pots we are able to make direct contact with ancient potters and their customers. Will 20th century potters provide such contact in 2000 years time?

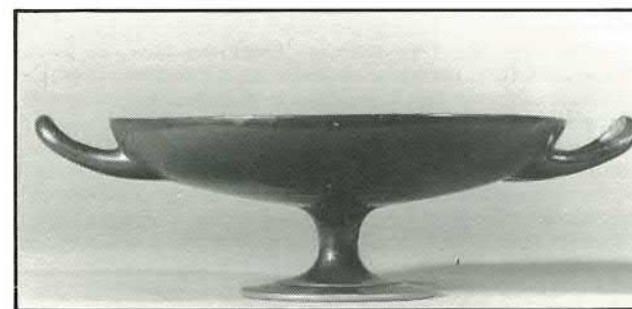

Fifth century cup, 9.1 cm high: 500-475 B.C.

Interior of 5th century cup. The tondo of the cup is decorated with a red figure scene showing a *symposiast* holding a similar cup and beating time to music with his free arm.

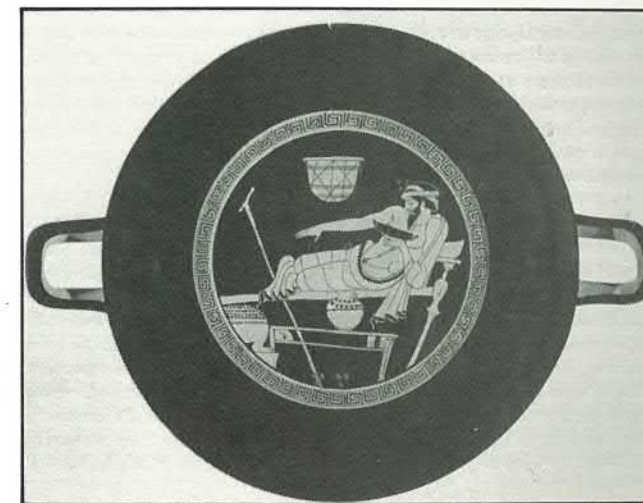

Black figure cup, 13.3 cm high: 575-550 B.C.

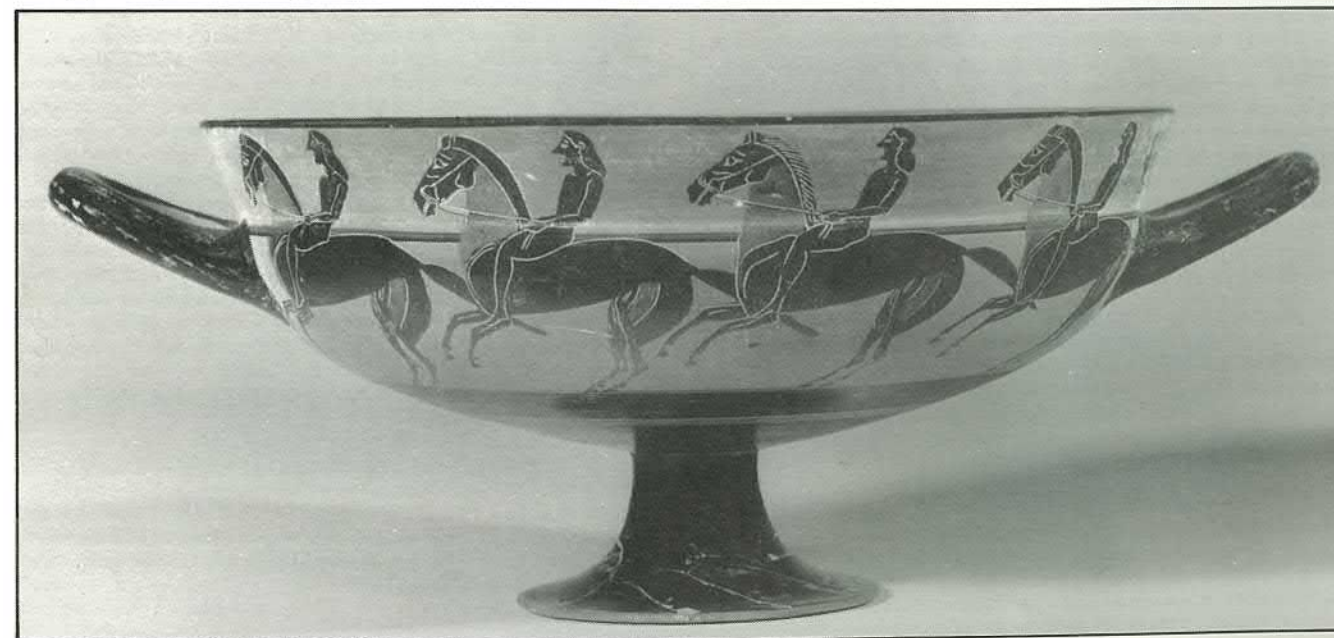

HAND CRAFT POTTERY, WHENCE AND WHITHER.

By Harry Davis, Nelson.

To understand the theme I am discussing here it is necessary to take into account a combination of social forces that coincided and gave the craft revival movement its particular ethos. The founding fathers of this movement were inevitably influenced by the values and characteristics of the culture into which they were born, and one must keep in mind how class-dominated that culture was. To further this understanding it is also necessary to define the main strands of that culture which caused them to orient the handcraft revival in the way they did.

The first strand and probably the dominant one, derives from post-Renaissance attitudes to what we understand today under the term *Fine Art* and the general acceptance of art as a thing apart from the rest of life — particularly apart from technics. This I must stress was not always so.

The second strand arose out of the fact that art appreciation and the acquisitive cult of collecting art became an essential element in the life of a "gentleman" and at the same time it became a very self-conscious thing. The education of a gentleman was incomplete without a study of the classics, the "grand tour" of Europe and a visit to Florence. All very much part of, and a buttress to, the class system which also required that a "gentleman" should not concern himself with manual, physical, and technical things.

The third strand was that element of social protest which gave rise to the handcraft revival in the first place. This alas was short lived. It was swamped by the egocentric and well established tradition inherent in post-Renaissance thinking. That is, the replacement of a tradition of anonymity by the competitive quest for individual recognition and fame which is now so inseparable from the arts. William Morris was the dominant figure in this protest, which was a two-pronged gesture, as much concerned about working conditions in 19th-century factories, as with aesthetic considerations in general, and the general absence of opportunity for creative expression for the people working in those factories.

One should note here that the protest came from a middle-class intellectual element and not from the factory workers who were quite unconscious of this aspect of their lot. It came, in fact, from a class whose members aspired to the status of "gentleman". A class that inevitably generated within the handcraft movement a feature which very greatly moulded its character. This was a fear of machines.

The materialism and sheer bad taste of so much of industrial production at that time was associated in the minds of those drawn to the handcraft movement with the idea that machines were the evil influence behind all they deplored.

Out of this grew the rejection of machines which became such a characteristic of the world of revivalist craftspeople. This was strengthened by the fact that this attitude to machines was conditioned by their class background which insulated them totally from contact with tools and machines.

A fourth factor which greatly influenced the character of the pottery handcraft revival was the role played by the arts schools. The influence of William Morris was still flickering in art schools after World War I. Some very halting pottery classes were functioning in the 1920s. The school that I attended had one, but interest centred much more on figurines than on pots. Pottery classes increased during the '30s, a fact that was much influenced by the advent of Straite-Murray as head of the ceramic department of the Royal College of Art in London during that period. After World War II the teaching institutions and pottery courses multiplied rapidly and finally spread to include a many secondary schools and even universities. All this became a decisive element in separating the art from the technics and facilitated the massive dependence on ceramic supply companies now so prevalent.

The final strand concerns the setting up by Leach and Hamada in 1920 of a pottery at St. Ives in England. I shall have occasion later to refer to beauty in the works of man which has so often been the outcome of technological limitations in the past. Given unlimited technical scope it is rare that restraint and good taste will prevail. And this is where Leach and Hamada's special contribution comes in. They had been inspired by elements of austere restraint in the work of potters in the past, Chinese, Japanese and Korean, which had essentially been imposed by technological limitations. They must have been conscious of this and it stands to their great credit that they accepted these limitations as a form of self-discipline in the aesthetic which they sought to recreate. Unfortunately this was carried over into the fields of practical technology which were not relevant to the aesthetic. This is a theme to which I will return.

My involvement with the handcraft revival was the result of other socio-economic forces which had caused the decline of traditional potters during the 19th century. From the time of Josiah Wedgwood's rise to fame in the second half of the 18th century, the traditional handcraft potteries of the English countryside underwent a steady decline. Very few were left with a viable socio-economic role or a credible aesthetic after World War I. Some survived by switching to the gift and tourist souvenir trade and a number of new establishments came into being to exploit this development, though the social idealism and aesthetic sensitivity of William Morris played no part in this. It was a totally unrestrained and undisciplined phenomenon using every available resource that 20th-century technology and chemistry could offer, and these were used without sensitivity or restraint.

When I was 16 I worked in such an establishment as a decorator. There I acquired some of the potter's basic skills including throwing, but none of the values which were already taking root in the embryonic pottery craft movement. I was in fact unaware of its existence until the economic slump of 1929 caused me to become unemployed. However, there was an element in my background which rendered me susceptible to those values when I was finally confronted with them.

My home was an incredibly cluttered place. The emphasis was on "art" with Victorian overtones. My father's first wife had been a portrait painter of some standing and my father was a prolific Sunday painter, which meant that every inch of wall space was covered with oil paintings in elaborate gilt frames. My mother was Swiss and this had made it possible for me to glimpse the interiors of mountain farms in that country and I liked their honest simplicity which was so unlike my home. The aesthetic of this simplicity became something of a yardstick for me and has remained so ever since.

One day I received a letter from my former employer telling me that a Mr Bernard Leach was seeking trainees for a pottery project about to be established at Dartington Hall in Devonshire, and that if interested I should write and apply. This I did. This opportunity was a major turning point in my career as a potter, and an important educational experience, though paradoxical in that it was the outcome of experiences of such negligible worth. I had, however, learned to throw from a very skilled old-timer and it was that which made me acceptable as a trainee, in a setting incidentally, where throwing skills were not of a very high order. Michael Cardew used to denigrate his skills as a thrower, remarking that there was at least one thrower less competent than himself and that was Bernard Leach.

Dartington Hall is a very beautiful Manor House dating in part from the 12th century and it struck me at the time that it was another instance in which great beauty was the consequence of technological limitations peculiar to the times in which it was built. It had, and still has, a magnificent and austere simplicity conceived in stone, slate and wood and blends perfectly with its very beautiful surroundings. The Hall had been restored by Dorothy and Leonard Elmhirst to become the vortex of a group of industries and crafts and at the same time a centre where the arts could be fostered.

The concept was that of an antidote to the drab and unaesthetic congestion of industrial cities and had affinities with the social and cultural concerns of William Morris. I felt excited and privileged to be able to participate in this. After a short period of work at Dartington I was required to go to St. Ives where Leach and Hamada had set up a pottery a decade earlier. Thus at the age of twenty I was introduced to an altogether different sort of pottery in which those qualities of aesthetic restraint and austerity were cherished. This time that familiar but sordid preoccupation with the making of things solely because it was assumed they would sell, seemed to be absent. Bernard Leach, saturated as he was in aspects of oriental pottery and mainly familiar with high temperature ware, was much committed to certain austere qualities which that implied. His home reflected this too; its furnishings were simple and sparse. There were rustic beds that Hamada had made and a few well-placed pictures. The house itself repeated that respect for ungarished stone, wood and slate peculiar to another and less developed age. I was very impressed with the way it contrasted with my own home. Bernard Leach was an inspiring interpreter of the work of potters in widely separated periods and places. He was also a brilliant draughtsman in the Augustus John tradition, having worked at the Slade School of Art about a decade after John was a student there. This gave his decorating on pots and his drawings a stamp which I greatly envied and admired. He introduced me to pots in a way entirely new for me, and I began to see things that I had not seen before, including pots that were unfamiliar in England at that time.

In 1935 something momentous happened, especially for me. There came to London an exhibition of the Arts of China through the ages. A gathering of potters and pottery students was organised and we all met in London at Burlington House to spend several days looking at this wonderful collection. The memory of it stands out as a landmark in my development. There I met Michael Cardew for the first time and he too was seemingly overwhelmed by the simplicity and the exquisite combinations of vigour and refinement. I was amazed that so much delicacy and sensitivity could be expressed with a floppy brush or a bit of bamboo. Here we thought we saw a prototype or a model of vigour and sophistication appropriate to the needs of our time and therefore a yardstick for what was theoretically going to happen at Dartington. But somehow it never did.

At about this time Staite-Murray was made head of the pottery department of the Royal College of Art in London and I know that this was something of a blow to Bernard Leach, because he had been hoping the job would be offered to him. Leach and Staite-Murray had been rivals as leaders in quest of fame and status for some years, holding periodic exhibitions of their work in London galleries. Staite-Murray it seemed had managed to make the bigger splash and had landed the job at the Royal College. His pricing, as everybody noted, had been substantially more audacious than Leach's.

Gradually, and now in some alarm, I became conscious of something which had not at first been apparent to me. This was the fact that my mentors hated machines to a man — including Cardew. Soon I realized that this was because they feared them, and their ignorance of them was total. Coming from middle-class backgrounds, tools for them were alien things and machines were something worse. They had no interest in or understanding for either. While I worked for Leach — nearly five years — there were no mechanical aids of any sort in the pottery. The nearest thing to a machine was a potter's kick-wheel. How Leach was able to reconcile himself to something as sophisticated as a crank shaft, I never did understand.

Slowly I became conscious of something else which I found perhaps even more disquieting. This was the growing pre-occupation with status which was apparent in several ways. The work effort rose to a feverish pitch in preparation for exhibitions, but after they were launched things slumped into inactivity. They seemed to be the real, if not the only stimulus for making pots.

Michael Cardew was seemingly quite unaffected by all this, or maybe he was as yet unaware of the status-oriented twist things were being given. He had revived Winchcombe pottery and was working away quietly as country potters had done through the ages with admirable disregard for mercenary considerations. His lifestyle was extremely simple and when I visited him for the first time around about 1935 he and his wife Mariel were living in a loft in the old pottery building. When he finally did hold an exhibition of pots

in the Brygos Gallery in 1937 he made an interesting comment, which alas, he was to hotly deny when reminded of it in the '70s. He said, "When they come at some future date to assess this event they will call it Cardew's ambitious period." I didn't press the point further, but clearly he was fully conscious of the turn that events had taken and his own involvement.

Long before this Leach had been saying repeatedly that pottery and potters must be given the status and prestige accorded to painters and sculptors. The title *Artist Potter* began to be heard more and more and it was clearly here that the pathetic obsession with the desire for recognition began for potters. Staite-Murray at the Royal College was soon heard to be saying that an Artist Potter must at all costs avoid involvement with function. All this was gradually reflected in the use of language. Things were renamed and acquired subtle overtones of *class*. An apprentice became a student, a shop was called a gallery and the potter's place of work became a studio! Recognition at any price had become the rule.

The potter's craft through the ages has had a special quality in that it performed a double function. It supplied a range of domestic and ceremonial pots essential to the daily life of ordinary people and at its best it enriched their common life on a spiritual plane as well. Potters have done this for a very long time, and often in more sensitive mood, obvious joy was taken in doing so. The pots — often quite mundane functional pots too — were imbued with a beauty and subtlety of the highest order and, as we all know, the technique is an inexpensive one, the raw materials used are abundant and therefore cheap, which is why such delightful things could become a life-enriching experience in anybody's daily life. Making this benign contribution to the domestic and social scene has been the potter's role and privilege for millennia, but to do this well, the potter had to be dedicated, hard working and have the wit to control his mixtures and kilns.

Suddenly in our day the potter became ambitious and decided to make a bid for a place in the world of Fine Art. In consequence everything had to change. The potter's social status, the kind of pots made and the attitudes to the repetition of shapes and designs, together with the need for skill and training, all underwent a rapid and total change. He had to invade a new kind of market place, ingratiate himself with a new kind of clientel and above all take an entirely new attitude to price. The new client was no longer of the common people and price was pitched at such a level that an ordinary home could no longer be its place. Instead it was destined for the collector's drawing room or a museum. Skill, if not positively denigrated, became unimportant. The extraordinary thing is, that despite all these changes, the pots in so far as they remained pots — which in many cases they soon ceased to be — were not one wit better than countless pots made unselfconsciously in other times and places by unknown peasant craftspeople without any pretence at status, either artistic or social.

The upshot of all this was that the potters no longer needed to be on their toes in any practical, technical or functional sense. If the pots were *Art* the rest was at naught and price or a teaching job would take care of the rest. In fact the none too subtle evidence that these aspects had been set at naught often became the hallmark and guarantee that the work in question was *Art*, which then was further underlined by the price tag. For some, the same evidence was also proof that the work was hand made and that authorised similar special pleading. There were thus two basic trends at work, both pulling in the same direction and both likely to have the same sort of impact. On the one hand there was the growing pre-occupation with status for potter and pot, on the other there was this Luddite mentality rejecting machines and tools, which seemed to sanction an indifference to practical and economic issues. It is small wonder that for many, even making pots soon ceased to be the aim and the acquisition of skill as possessed by that *Unknown Craftsman* so much admired in those days, no longer held interest. Similarly the more mundane needs of daily life — dinner plates for instance — could hardly be tackled at all, let alone given that extra shot of vitality to enrich the experience of day-to-day living, without pricing them out of the common people's reach.

The Elmhirsts in the meantime had ceased to administer the Dartington Estate themselves and had appointed a group of professional trustees to do it for them. The Trustees may have had reason to doubt the practicality of the scheme — anyway the dream project was quietly dropped.

Lewis Mumford has made a very important analysis of man's attitude to machines and the machine age, in a book entitled *The Myth of the Machine*. This has a bearing on attitudes that have greatly influenced trends in the handcraft movement — especially pottery — attitudes based on what were in fact fallacies. Many eminent men have pointed the finger on this theme, but also mostly in the wrong direction. Ruskin, William Blake and JJ Rousseau all had their mistaken rant about machines. A machine can be a benign labour-saving device. It is its misuse that makes it malignant, when people are made to tend its monstrous and monotonous demands or starve — when it is used to get more out of fewer people for less money. The real foe, as Mumford makes historically so clear, is that great invisible organisational machine called variously *the system, the establishment*, which he terms the *megamachine*. It is that ruthless instrument of collective coercion once used to build the pyramids under mortal threat and more subtly applied in later times to man the factories for a pittance, or starve. It is essentially a product of *civilisation* and also the prolonged event that led to the widespread view that work is a curse which should be avoided if possible. Only when free men operated outside this thing, or were given freedom to do so within it, was creative craftsmanship a possibility and work a joy. For the fact that at times this did happen, we are grateful.

The building of machines in the benign sense started very early. There is the record of the poet Antipater (of Thessalonica) writing a eulogy of the water wheel as a domestic appliance relieving the women of the burden of grinding corn. This was in the 1st century of our era, somewhere in the mountains of Greece, though water-wheels have a history very much older than that. The real boost came with the Benedictine Monks in the 6th century. That order with its working day of voluntary discipline divided into mental, spiritual and manual duties, had a vested interest in the invention of labour-saving devices, if only because there was no place for slaves or bosses in their way of life. Mumford has calculated that the cumulative effect was that by the time of the Norman conquest, England with its population of only one million had the labour services of 8,000 water-wheels. These, he further estimates, yielded energy annually far in excess of the reluctant labours of the 100,000 slaves the Egyptians used to build the Great Pyramid. Such an achievement as early as the 11th century is impressive engineering, no matter how negligible it may seem by modern standards. To have all that sawing of wood and milling of grain done for them, to say nothing of devices for harnessing a horse to chop, cut or stir, enables one to begin to understand how a town of 10,000 people could raise one of those magnificent cathedrals without recourse to slaves and the lash. That was a cultural peak in the remote past, but proof enough that the machine can be benign in the hands of free men. Since then the megamachine has reappeared in new guise and the words *wage* and *industrial* have been prefixed to new and subtler forms of slavery.

Bernard Leach again saw clearly the vicious break between the generations of potters associated with the English slipware tradition, culminating with Thomas Toft in the mid 18th century, and the generations of industrial workers starting with Josiah Wedgwood's employees, that followed. There exists an amazing milestone to mark this event — a letter from Wedgwood to his friend and PR man Thomas Bentley in which he writes of his dream, "to make of men, such machines that cannot err". A century and a half later William Morris began to protest at the social and aesthetic outcome of that 'dream' so effectively fulfilled, and of course not only by Wedgwood.

The craft revival movement was essentially a gesture of protest from the start. Everything ever said about it in those early days was based on criticism of things as they were at that time, contrasted with what had been in other times and places, and there was no isolating those contrasts from the social conditions that gave rise to such startling results. An awareness of the sordid dreariness of 19th century industrial conditions and the tasteless ostentation of its products, provoked indignation and varying degrees of resolve to take some part in a solution.

This was the mood of the handcraft pottery revival as I experienced it in the '30s. There was no escaping the fact that the tastelessness was linked with unprecedented material wealth and that anything artistically and aesthetically inspiring out of other ages was associated with what today would be called poverty. What was the factor producing such differences between the sterile quality of artifacts in the 19th and 20th century urban life and the aesthetic vitality of artifacts that came out of material poverty in primitive tribal conditions at other times. My conclusion is that it had to do with a social ethos which yielded or denied people the freedom and satisfaction of expression in simple humble acts, regardless of material rewards or status. The essence of it seemed to have to do with simplicity and austerity and many of us realised that if we were going to recapture anything of that vitality, it would only be possible through a voluntary acceptance of what some would call poverty, but which others prefer to call simplicity.

To me there was something contradictory and repellent about striving for a simple and vital aesthetic in what we did and selling it in places where only the wealthy would go to buy it — and at no matter what price. Vitality and simplicity needed to be brought back into the humbler things associated with ordinary living and sold where the not-so-wealthy would be expected to buy what they needed. Clearly price and inevitably competition, had a lot to do with it. The question was how to do anything in the face of industry churning out its characterless products with such immense material resources at its disposal. What one did would have to be the outcome of a radically different approach. That the emphasis on motivation must be reserved was agreed — putting the emphasis on giving and not taking. Something any craftsman worthy of the name does anyway and usually with a generous mental idea about price, which they may never have tried to define, though others have. In the days of cathedral builders they called it the *just price*. What that is, is not too easy to define either, but it certainly differs from that other and more recent definition of price which postulates that "the price of an article is what it will fetch" — a yard-stick soon to invade the world of potters as well. This wasn't overlooked by a group of prisoners in an English gaol recently. They were given pottery classes in the prison rehabilitation program and were in the habit of sending their pots home to their families with false signatures on them. Someone took the next obvious step and for a time they managed to fool the famous London art dealers who were well versed in the "what it will fetch" rule, sometimes to the tune of millions. The prisoners, however, overlooked one important point — the exclusivity principle. They made just too many Bernard Leach pots.

The combined effect of the changed attitude to status and the quasi-Luddite thinking was soon to be strengthened by an awakening in educational circles. This was an area already hopelessly committed to the split between techniques and aesthetics. Technical colleges to teach techniques and Art Schools to teach art had long been a feature of our culture which was pushing apart things that always in the past had been facets of a single whole. A central concern of the craft movement should have been to bring these two together again, but it was not and they continued to drift apart. Staite-Murray's message that an artist potter should avoid all involvement with function spread rapidly through the Anglo-Saxon world of teaching institutions when the teaching of crafts was about to undergo a tremendous upsurge. The very multiplicity of the institutions and the great number of courses introduced meant that henceforth the craft movement was to be in the hands of educationalists instead of working craftspeople. This effectively diverted attention away from the capacity craftspeople in previous cultures had for avoiding a split between the practical and the creative.

This rapid stimulation of activity meant that the institutions had first to produce a generation of teachers, to teach whatever was to come next; they did not, and could not, produce a generation of practical craftspeople, or tradesmen. I use the word *tradesmen*

deliberately because of the light it throws on the changed role of both tradesman and craftsman in modern usage. The term *tradesman* is so irrevocably associated in our minds with the idea of trade and commerce that only when its archaic usage is brought to our notice do we realise that it implied a certain dignity with ethical overtones, and combined the efficiency of a skilled craftsman with an unmercenary idea of service. The prefix *trade* had originally an altogether different and dignified meaning — to tread or walk, as in a calling. This was bound up with the trio *apprentice, journeyman, master* and conveyed the idea of the craftsman treading on a way of life with a sense of mission. It is interesting that the German word *beruf* equates exactly with the English word *calling* and is used to denote what a person does, whether he is a potter or a university professor and carries none of the mercenary market-place overtones now irrevocably associated with trade and tradesmen in English.

There are two sides to every craft. The one concerned with practical competence, skill and viability, and the other with imaginative content and aesthetics. It took an industrial revolution and generations of regimented workers drilled in the routine of subdivided tasks, before the rediscovery was made that these were perhaps after all not two distinct things, but different aspects of a single whole. In a class-ridden society like that of England in the 18th and 19th centuries, the loss of the tradesman's dignity and the splitting apart of the two halves of a craft could happen and not be noticed, not even by thinking people. Given the thinking of leaders like Josiah Wedgwood, that cleavage was inevitable. Equally inevitable was it that those more sensitive people who became aware of this affront to human personality and dignity were among an intellectual minority that was insulated from those lowly occupations dealing with the mere practical and technical sides of life. When they stopped in their tracks, as Morris did, saying, "This must be changed — craftspeople once made beautiful things and now look what people are made to do", they were ill-equipped and their understanding of tools and techniques was minimal. Their background and education had given them instead a grounding in Latin and Greek and some familiarity with what are called the fine arts and literature.

Their thoughts were coloured by a succession of thinkers who had misconstrued the very nature of what they knew as the machine age. Educated gentlemen that they were, they would have felt the influence of Rousseau, William Blake, Ruskin and others, all of whom detested machines; Rousseau has even been described by one authority as the original Luddite. One and all confused the benign thing of wheels, shafts and pulleys that will do back-breaking chores for a craftsman, with the vicious organisational machine of workers, foremen, managers and bureaucrats (to say nothing of shareholders), that regiments the worker and leaves no place for imagination and spontaneity, to say nothing of his growth and dignity as a person.

The educational institutions were saddled with this misconception and instead of accepting the two halves of a craft as complementary to each other, like the material and spiritual sides of human personality, they persisted in denigrating one and worshipping the other. Even now it is rare to find any attempt being made to find a balance. With the basic technical and material aspects thus ignored for perhaps two generations, the door was left wide open for enterprising supply companies to render the whole craft movement pathetically dependent on their services. In the 1920s technical know-how and resources appropriate to the needs of the movement abounded and had there been the interest and receptivity, a whole battery of simple technology could have been harvested to strengthen the arm of a generation of revivalist craftspeople. However, the specialist syndrome was already dominant and education did absolutely nothing to heighten receptivity to this plethora that was about to be wasted and lost. Only when Schumacher said his piece about small being beautiful did people wake up to this waste.

It was not until I was thrown on my own resources in West Africa at the end of the '30s that I became conscious of the abysmal ignorance that prevailed among my generation of revivalist craftspeople. Not just the ignorance that defined my limitations as a potter, but my ignorance of so much that men in other "callings" in the years of my early adulthood could have bequeathed to me had I but asked. Those were opportunities lost because there then came World War II, after which those men and their workshops were gone.

Long before that it became apparent to me that the craft movement was confronted with a choice — either to acquire those specialised skills and get acquainted with some aspects of more specialised fields of knowledge, or abandon the early ideal of linking high quality in its broadest sense with moderate price. No other way can potters hope to fulfil the simple socio-economic service that was traditionally their role. The alternative is a great public relations act of self-advertisement and much subtle manipulation of language to create an illusion of exclusivity to justify inordinate price levels, way beyond the commonality of people.

For me in West Africa during the war these choices became part of the day-to-day challenge. The war had cut off all the normal sources of expertise and prepared raw materials, as well as the range of ready-made equipment. Either one improvised solutions from whatever was to hand, or one capitulated. I chose to improvise and carry on, and from then on my potting life has had what in modern jargon would be called a *research department*. For over forty years this has been a continuous side interest to discover ways and means to strengthen a potter's arm in practical terms, to compensate for the disadvantages, albeit voluntarily accepted, of moderate scale and handcraft methods. It adds up to a vast amount of information both theoretical and practical, and for the last two years I have been busy putting it all on record for a book which I hope will soon be published.

Someone once defined an educated man as a person who knows everything about something and something about everything. This is, I think, an apt definition of a well-trained potter. He needs to know everything about his chosen field and something about everybody else's. As it turns out his "calling", as defined before the industrial revolution, can scarcely be pursued at all today without a partial overlap with other specialised fields. This was brought home to me during the war in another sense as well. An attempt was made by the military authorities in West Africa to find me an assistant from among the British servicemen stationed in the three colonies Nigeria, Gold Coast and Sierra Leone. The opportunity attracted many applicants from men formerly in the pottery industry, but one and all were qualified in some minute fragment of the skills practised in that industry. They were all factory workers and there was not a craftsman in the full sense of the term among them. Such alas is the the scope for human fulfilment inside the megamachine.

What distresses me about this story of fifty years of craft revivalism, is the fact that handcraft pottery with its complacent standards of doubtful competence and extravagant pricing only flourishes because it is functioning in a society of extreme affluence. That affluence is the direct outcome of outrageous resource usage by the developed Western World, which is in turn a major cause of dire distress for the greater part of humanity living in less developed societies. There is a bandwagon quality about all this which, I submit, is not what the handcraft movement was about.

So much for the whence in my title. The whither is another matter. In my opinion the prevalent direction is explained by the values and motives which guided the handcraft pottery movement in its formative years. I have indicated what these were and it seems almost certain that they will continue to dominate its future despite the efforts of a minority who are struggling to find a way to operate on a healthier value basis. The prevailing attitudes and values have been instrumental in diverting the movement away from any urge it may have had towards creative expression, while meeting the needs of the commonality of people. A heavy bias in favour of aesthetics, as the only field of excellence worth pursuing, has for most potters become an exclusive bias and one often transparently confused with a concern for fame and name. This is not something new, but it has culminated in an extraordinary complacency. In fact the movement has become content with very low levels of skill and is positively indifferent to practical considerations that could lead to a more holistic and socially purposeful role — one that need not mean a loss of creative expression. This is a state of affairs that could only have come about in a society of extreme affluence — an affluence enjoyed by a minority in the human family which has so contrived the affairs of man that the resources of the world are automatically made to converge upon it on a scale out of all proportion to its numbers. Worse still this complacency renders the movement unaware of, and even indifferent to, the basis of this extraordinary affluence — an affluence which persists for its majority in spite of recessions and much unemployment. All this is sad in a movement which began in a mood of idealism with a broad social and human concern.

PIT FIRING WITHOUT A PIT

By Peter Gibbs, Nelson

It was Ray Rogers who was guilty of inspiring NZ Potters with large holes, plenty of smoke, a couple of beers and an armful of smudged pots which never remotely measured up to those of the master. Generally the event of firing itself included a large gang of participants, plenty of theories, and a few singed eyelashes.

It doesn't have to be that way. You can throw away a lot of the magic and excitement and reduce the experience to a much more mundane event by constructing an imitation pit above the ground, and reducing the size to manageable dimensions. At the same time, you can gain a degree of control and reproduce the best results time after time.

To get back to the beginning of the story. After Ray Rogers' Nelson workshop, I found myself with a large hole in the garden, and a steadily increasing pile of pots which, although they had received more than their share of loving burnishing and stroking, were just not good enough to sell. The main problem seemed to be inherent in the Earth. No matter what you do, you just can't dry it out in winter. The other problem was size. Fine in late summer and autumn, when all the pots would be just great, but in the winter, so many bad pots appeared all at once it did unspeakable things to our morale, not to mention our bank balance.

The solution was in the construction of a rectangular brick pit about the right dimensions to take a couple of days production, and built on concrete blocks to keep the bottom dry. The height was arbitrarily fixed at ten bricks because it looked right, and that turned out to be fine, although a few more layers would probably be an advantage for larger pieces. In building, one needs to take care to seal the whole structure, as reduction is the name of the game, and those air chinks can do a lot of damage to those blacks and brilliant copper reds.

If you have ideas of letting air in at particular times and places, build in air vents that you control. We also added a strip of angle iron along each side at the top. Not essential, but in this sort of structure where you're leaning in and out a lot the bricks start to work loose after a while

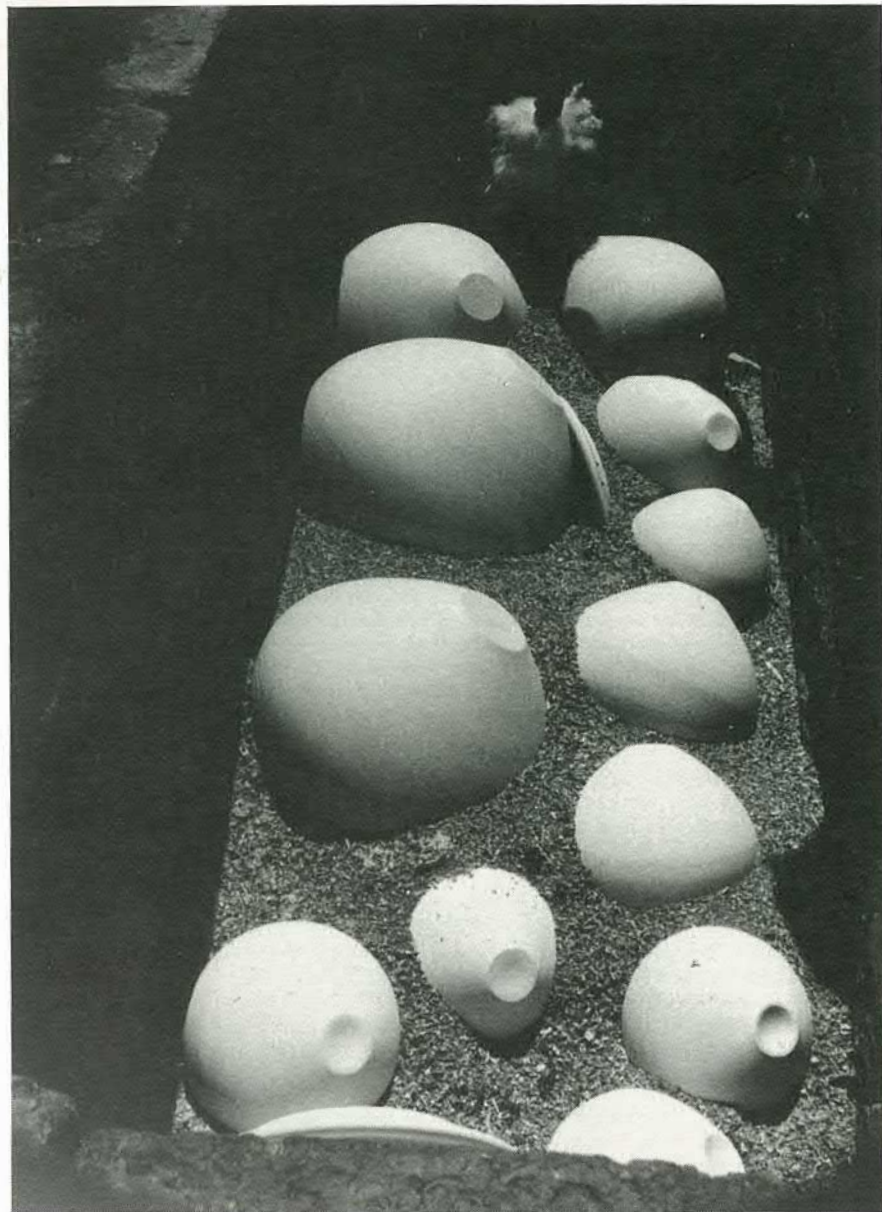

Pit stacked and ready for the wood

Having built this structure, and played with it for a year or two, we've grown into a particular routine of firing. First we pour a bag or two of dry sawdust into the pit, enough to give a depth of 100mm to 150mm throughout, more for larger pieces. We are often asked if the type of sawdust matters. Probably it does, but we can conveniently get a truckload each year from a local mill which mainly cuts pine and that works for us.

The sawdust is dried thoroughly on a concrete slab in the back yard, then stored in bags until needed.

Next step is to nuzzle the pots down into the sawdust. We have only one layer of pots in the pit, as that's where the best results happen, and why settle for less? How you do this depends on where you want the black areas on your work.

To get colour, we have found nothing more reliable than Copper Sulphate (Bluestone, available from most garden shops, or Stock and Station outfits if you want to save money by buying in volume), and salt. Both these materials are easier to distribute in the pit if they're dry. We generally

use one or two cups of each, and simply sprinkle them amongst the pots.

Because the best effects are obtained when the colourants are lying on the sawdust, and not up against the pots, I try to arrange the sawdust fairly carefully into channels between the pots by dragging a stick through before shaking the goodies over the top. I also use a feather duster to flick any scraps off the pots, where they would form their own messy little melts.

Having prepared the pit this far, just fill it up with wood. Again, different types of wood may have different effects, but because we live in a pine-prolific area and have tons of wood on hand for our stoneware kiln, all cut into 800mm lengths, this is what we use. In fact, the pit was built to just twice this length so that the wood fits in neatly.

The wood is stacked directly on to the pots, and as tightly as possible. No crisscrossing to let air in — air is not required here thanks. When the pit is jammed full, put some newspaper and kindling on top, light, and cover pretty well straight away with corrugated iron.

After a couple of hours, you may notice that the fire is burning mostly up each end, and perhaps in a couple of other areas where the wood was less tightly stacked. Just rake the wood out a bit to knock it into these spaces. Don't worry that it doesn't seem to be burning on top, you don't want it to get hot there anyway, and it will be burning happily below. In fact trial pots with low maturing glazes inside indicate that the temperature is close to 900°C. Without adding any further wood, and with occasional rakings every hour or two, you will find that after five or six hours you're down to about 200mm of glowing embers spread fairly evenly over the pots.

At this stage it's pretty well all over. Weight the corrugated iron down with a few bricks to reduce the air intake as much as possible, then go to bed. Next morning you should be able to jump up and open the beast.

The pots will look pretty good after a bit of a wash. Any rough spots can be knocked off at this stage by the judicious application of a bit of wet-and-dry sandpaper. They can be further enhanced by a light coat of furniture wax of some kind. It's easier to apply if you warm the pots in your kiln or stove first. Contrary to some fears, the colours don't fade unless you expose the pot to direct sunshine, or other tough conditions. You wouldn't do it to your piano, or expensive prints or paintings, so why should you do it to your pots?

Photo by
Lynne Griffith

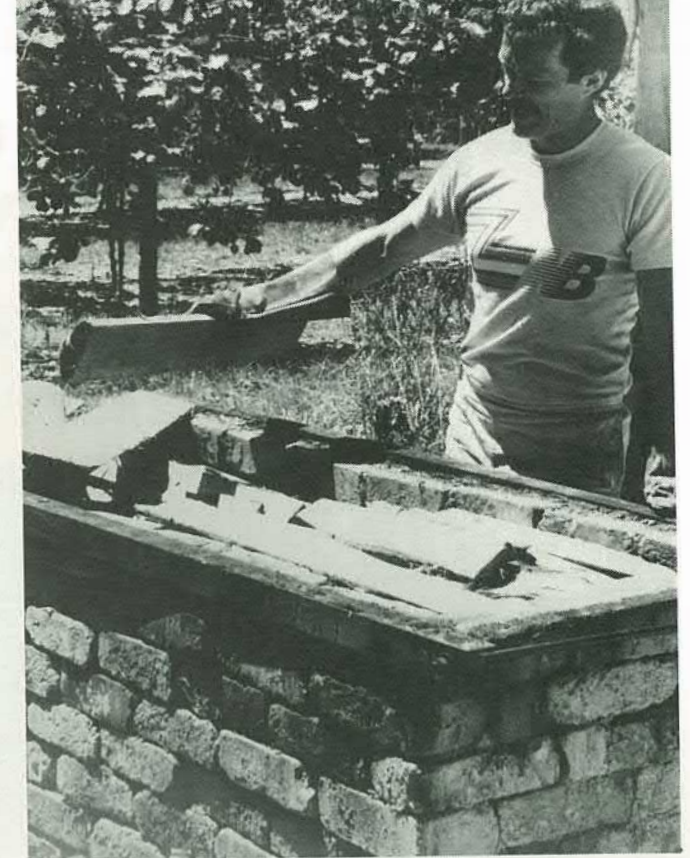

*Last bits of wood
being added on top*

Lit and happily firing

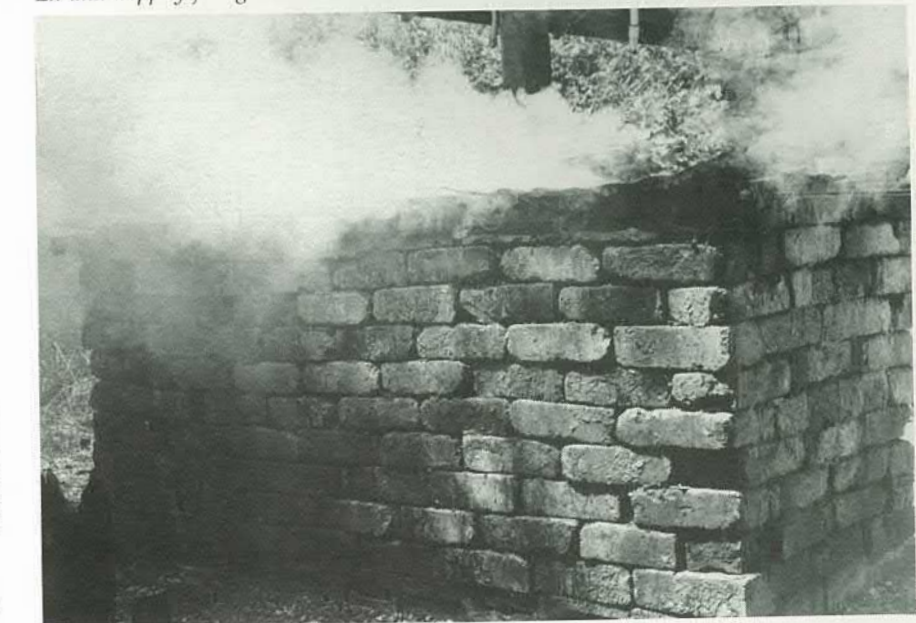

Finished pots, each about 100 mm high

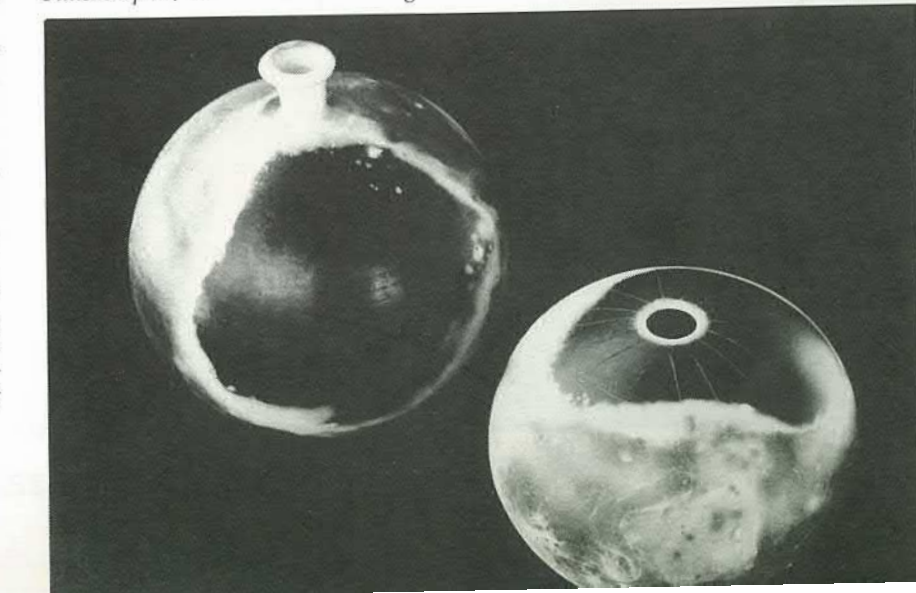

Theo Schoon

31 JULY 1915 — 14 JULY 1985

Further notes and photographs by Steve Rumsey, Auckland



1

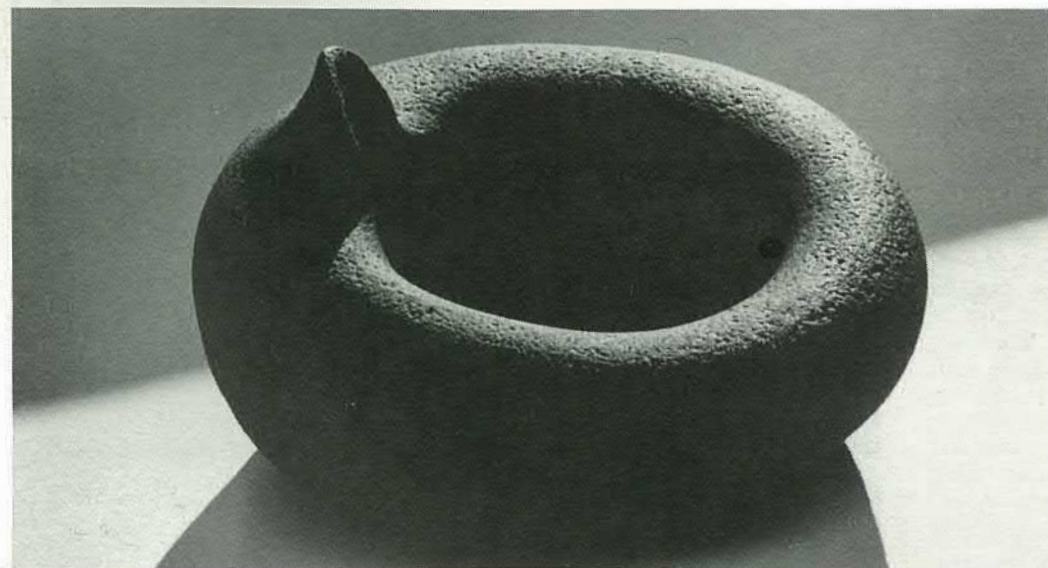

2

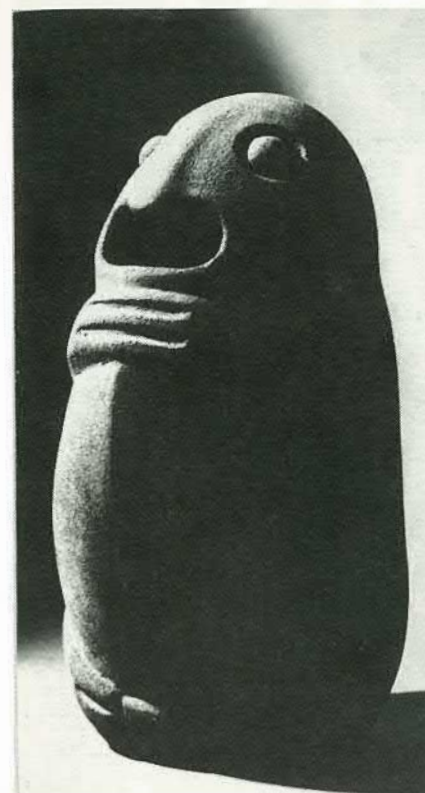

3

4

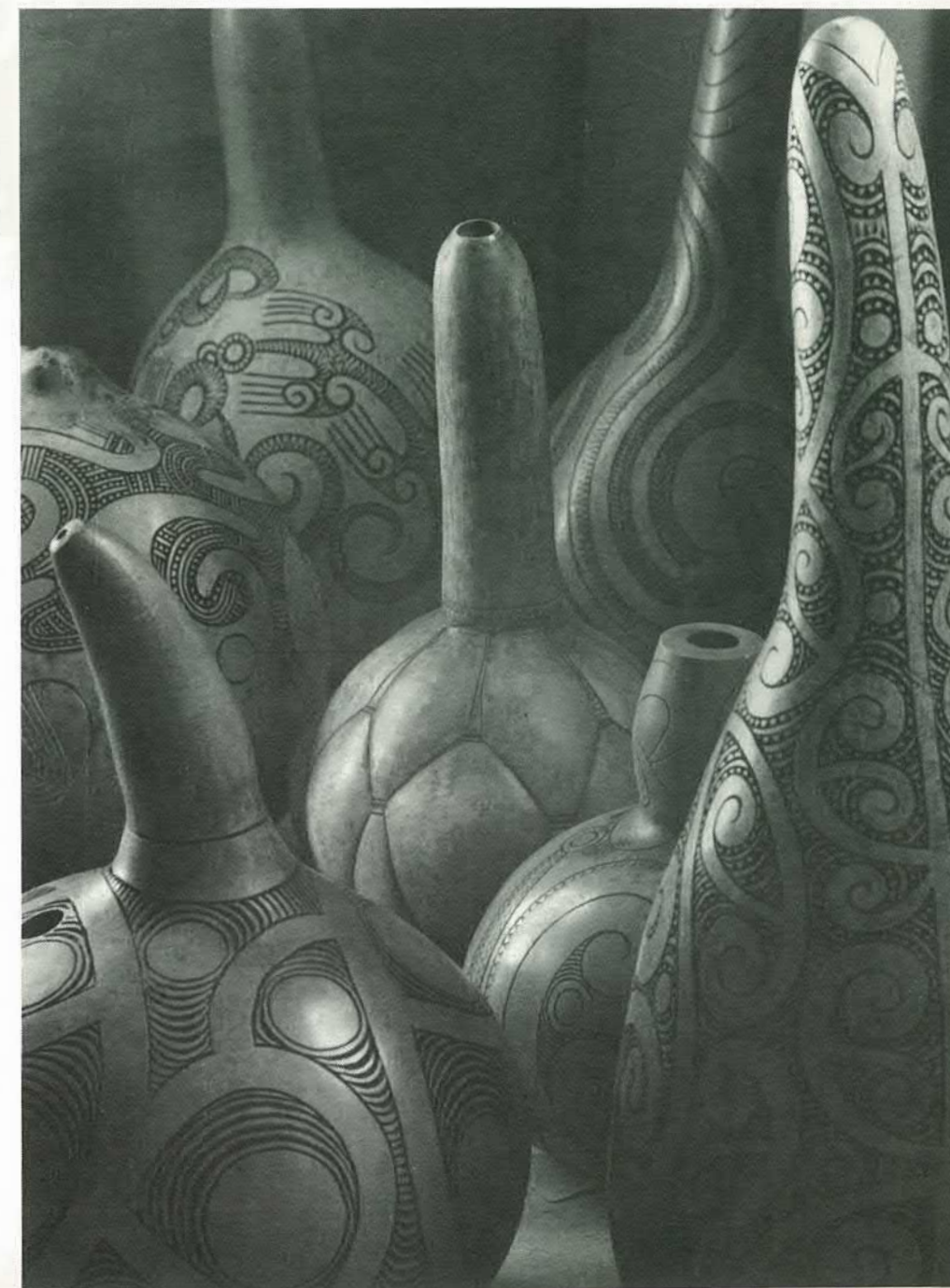

1. Growing giant African gourds at Home Street, Auckland 1961.
2. *Ash Tray*, made from unglazed vitreous stoneware. The clay was loaded with manganese dioxide and volcanic ash from Rangitoto Island. 1955. (Collection of John Crichton, Auckland.)
3. *Kumara God*, press-moulded form, stoneware clay bisc fired. 1955.
4. Gourds carved with Schoon designs. Right hand gourd shows a more traditional Maori *Koru* design. 1962.

Theo Schoon

Notes by Steve Rumsey

Theo Schoon died in Sydney 14 July 1985.

This happened while we were preparing the article *Impressed Decoration on Clay* (previous issue NZ POTTER '85/2) and I was unable to check some details of fact with Theo before his death.

It now appears that the Schoon family arrived in New Zealand in 1939. Theo's father had been Governor of Prisons for Central Java under the Dutch administration and the potteries referred to in the previous article were a 'side-line' industry for Governor Schoon! They made heavy clay products such as bricks, tiles and drain pipes.

Due to hazards of editorial layout, Theo's graphic design in the last issue was printed on its side, while the original caption was contracted to imply that this design was *directly* derived from Maori *Moko* (tattoo). This is not strictly true, for while all Schoon design became permeated with a strong sense of structure derived from his intensive study of Maori *Moko*, rafter pattern and cave drawing, this particular design was perhaps more directly inspired by his observation of the form of silica-coated debris in the Waiotapu thermal area

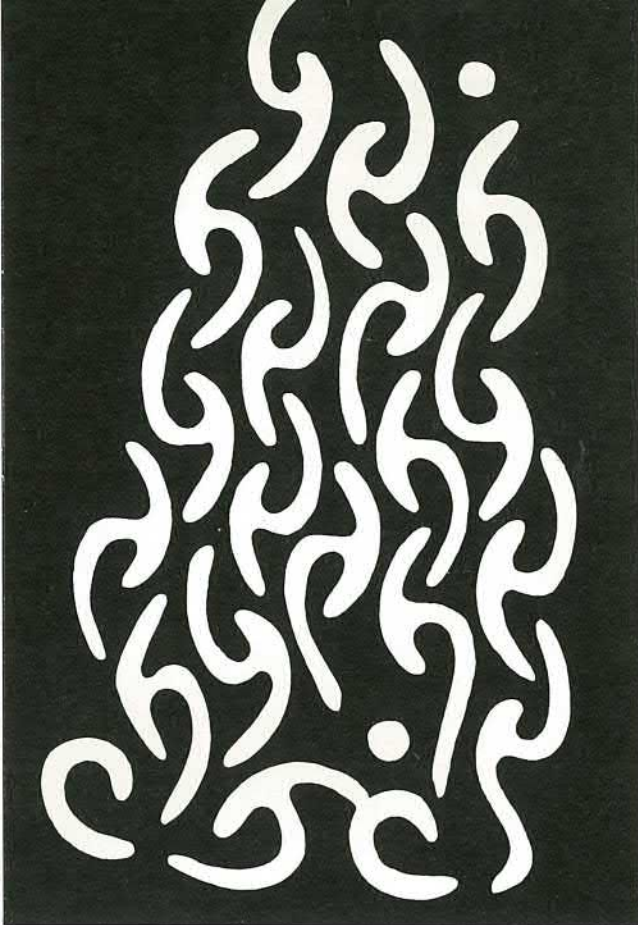

The artist in Theo often came to the fore in his photography and he was not beyond 'improving' on Nature: this silica terrace with debris, is augmented by Schoon contrived plasticine forms!

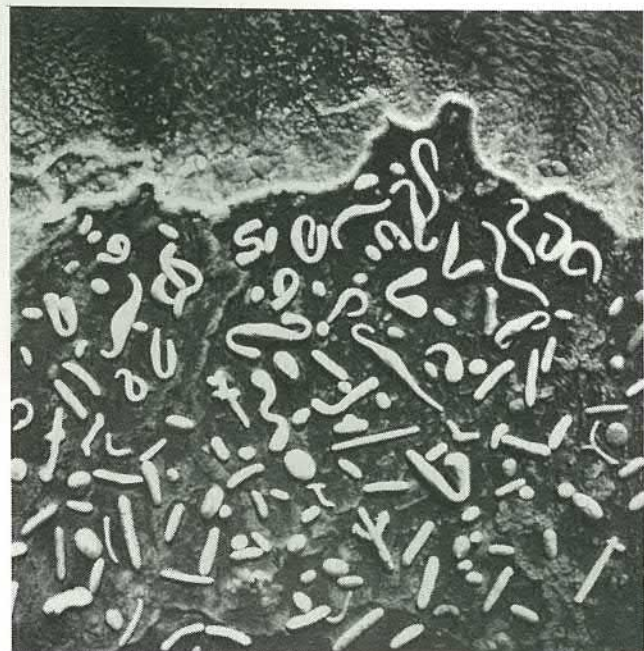

Schoon photo of natural silica-coated debris from Waiotapu. The design elements of the above graphic can be readily identified in this photo.

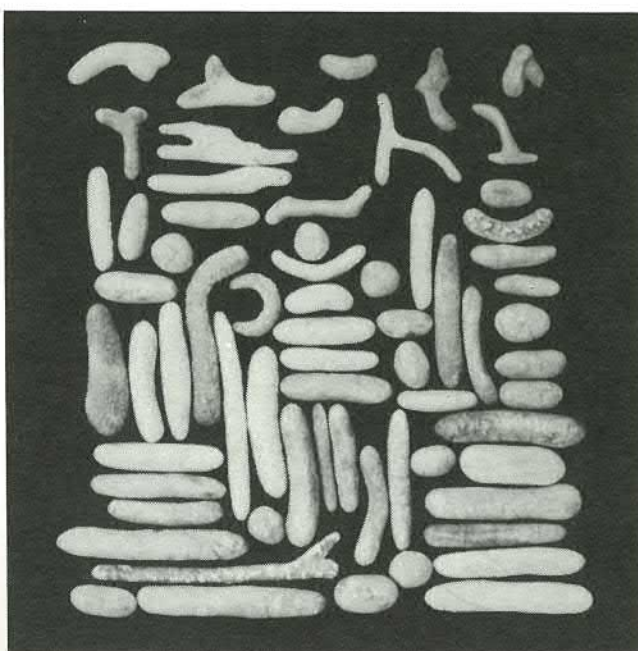

INEXPENSIVE SPRAY GUN

By Andy Pretious, Palmerston North

This is a glaze spray gun I made using an old *Vegemite* jar and a few pieces of copper tubing. It works well, spraying anything from oxides to a *papa* glaze sieved through an ordinary kitchen sieve.

All the pieces are soldered together. Adjust the suction pipe up or down to obtain the best spray pattern, before soldering it in position.

Preferably use copper or brass tubing to eliminate any rust problems. If your jar has a plastic lid instead of a metal one, assemble the tubing on a large washer or copper disc, and bolt this to the plastic lid.

Air is supplied from an old fridge compressor — the sealed dome type — via a length of plastic tubing.

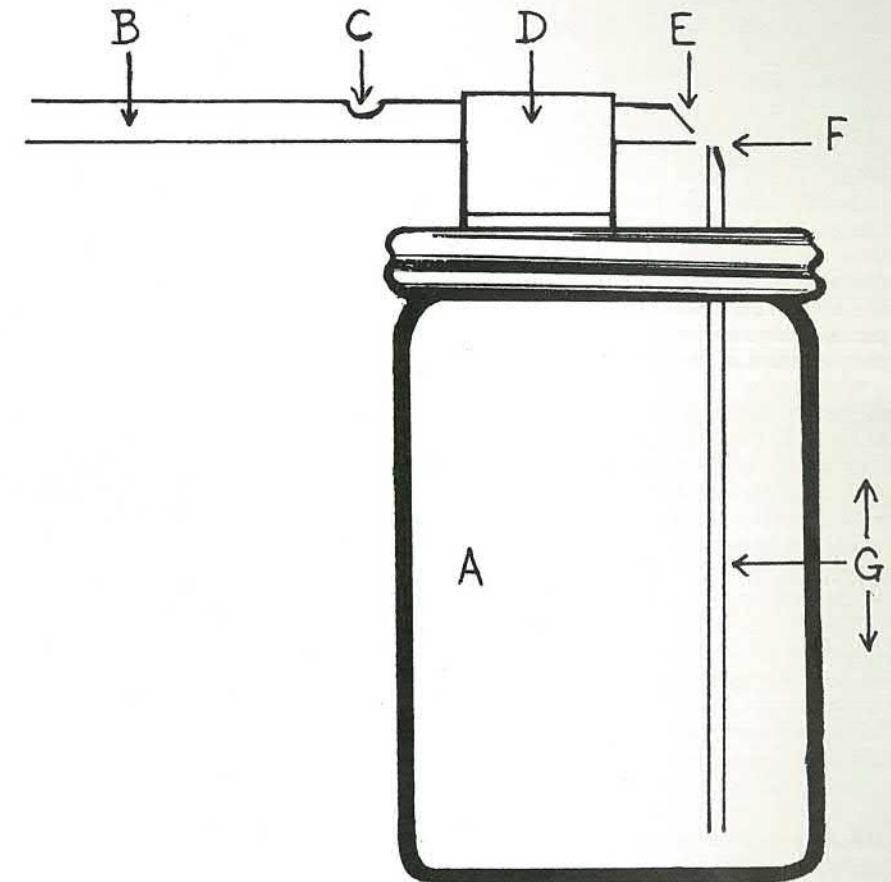

- A. Vegemite jar with metal lid
- B. 6 mm copper tubing
- C. Air control hole, approx 4 mm. Cover with finger to spray
- D. Copper bracket
- E. Reduced to approx 2 mm hole
- F. Reduced to approx 1 mm hole
- G. Suction pipe, 3 mm copper tubing. Move up and down before soldering to adjust spray pattern

U.K. Potters 7th Edition

Published by the Craftsmen Potters Association of Great Britain.

Potters is the illustrated directory of the work of full members of the *Craftsmen Potters Association*, and a practical comprehensive guide to pottery training in the United Kingdom. This the 7th edition has been completely revised and given a new format. As well as illustrations of potters' work, there are also for the first time, pictures of potters at work in their studios.

Names, addresses and telephone numbers of all full members of the CPA are listed, together with details of visiting times, showroom openings and invaluable information for anyone planning a visit. A specially

drawn map shows where workshops and studios open to the public are situated.

The section 'So you want to be a Potter' on pottery training has been expanded. As well as general advice and lists of degree and vocational courses available at art schools, colleges and institutes of higher education, there are course descriptions supplied by the colleges.

Additional information on the *Craftsmen Potters Association* lists evening meetings, activities and exhibitions. With over 270 black and white illustrations, this is a valuable and useful survey of studio pottery in the U.K. today — an excellent reference book. Copies cost £5.95 (by post £5.95) from:

Ceramic Review Books
21 Carnaby Street
London W1V 1PH
England

The Secret of Leadership:

Some you lead, some you drive, some you bribe — but for heaven's sake don't get them mixed up.

"In teaching you want to do two things; to teach the fundamental principles that transcend momentary fashion, and then to teach what is currently going on. The two are compatible, but undue emphasis on one or the other is not proper design education." Milton Glaser.

Don Reitz at a potters' convention near an Indian Reservation, somewhere in the US of A.
"How did you get to be chief, Chief?"
"I ran over a potter with my jeep!"

"TOO MUCH STILL AIN'T ENOUGH"

Casey Ginn, USA : Raku workshop at Nelson Polytechnic

By Graham Egarr, Nelson

"Too much still ain't enough." was a comment made by visiting American potter Casey Ginn that pretty well summed him up and his work. Casey, on holiday in New Zealand from his hometown on the coast of Alabama near Mobile where all his neighbours are prawn fishermen, was pressed into running a two-day workshop on raku at the Nelson Polytechnic.

Wednesday night we gathered around to look at a selection of slides representing Casey's current work and that of some of his friends — a mere 20 slides that took all night to view, such was the interest and excitement that engendered so many questions. The brilliance of those big orbicular pots was stunning — pinks and reds, velvet crimson with yellow and green all flashing into each other, off-set with matt black and crackle-white glazes. And how could you get those columns growing from the spheroid base, from the raku kiln without losing them from thermal shock? The secret was *Kyanite*.

Kyanite is the raw, or unrefined and therefore affordable form of mullite and has the valuable property of expanding as silica contracts in the cooling process; thereby relieving the pressure in the pot as it is sprung from the kiln into the reduction/cooling phase. Up to 30% wedged into the pot clay body ought to be enough, but for Casey's sadistic techniques the tortured pot could well do with a trifle more. Never-the-less we multi-fired a large pot from a well grogged S.C.80 claybody; it survived thanks to some excellent throwing techniques that Casey demonstrated — thin and uniform and as light as a feather.

The first decorative effect to perfect was what Casey called the 'Halo' effect. The basic principle was to slip a white-firing engobe over portions of the pot and then brush decorate with an oxide mix of iron and copper. This pot would be heavily smoked after coming from the kiln. Carbon could produce mid to dark grey on the exposed clay body of the pot, light grey on the engobe, and black on the oxide

Photos by Lynne Griffith

decoration. The crux was to slow the cooling so that the oxide, retaining more heat in the metal particles than the engobe, would burn off the carbon on the engobe along the very edge of the oxide wash. The result would be a fine line of white before the engobe reverted to a mid grey; a halo that would pick out the wash decoration in silhouette. Just the right amount of carbon and the right amount of heat was the key to this one. And if it didn't work? Refire and try again.

The second decorative effect used a wash of copper and fritt as a flux. This needed to be fired to just the right temperature, cooled slightly before being reduced and cooled. Again, at just the right temperature, allowed to cool in the open air. If the beautiful brilliant pinks, reds and purples did not appear, the pot needed to be refired. After numerous firings you got it right; there are so many variables that you need at least two firings to figure out just how your individual pot is behaving throughout this cooling, reduction, and oxidising process.

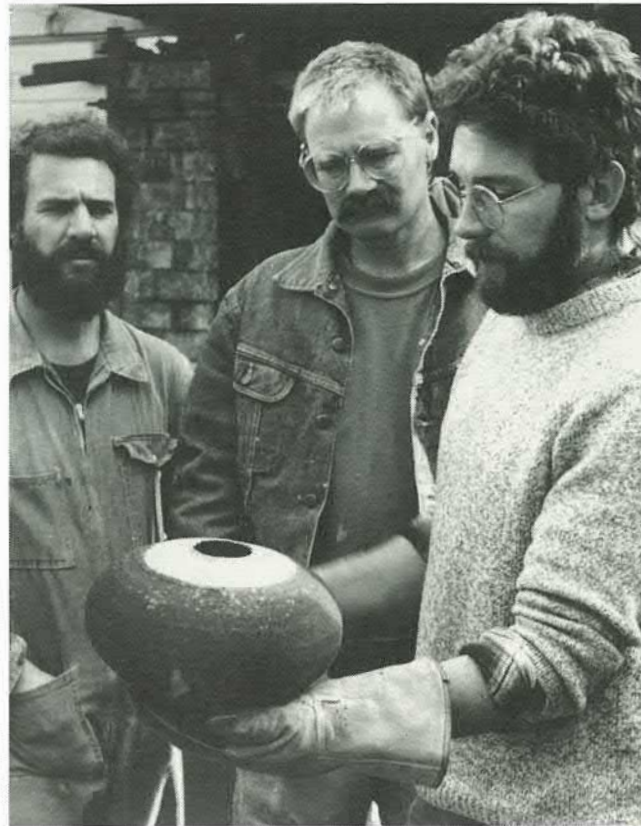

Casey Ginn casts a critical eye over the red-hot raku piece, watched by Graham Egarr and Steve Fullmer

Casey's demonstration pot illustrated this well. When the pot had reached just the right temperature — probably around 950°C, the kiln was opened and the pot allowed to cool slowly for some 15 seconds. It was then whipped across onto a bed of wet sawdust and newspaper prepared in a dust-bin. When the bin was full of smoke, a covering of wet newspaper was clamped on to it and the pot left to cool for 12 minutes. Upon opening, a dull ochre-coloured pot appeared. Casey announced that it was too cool upon going into the bin — try again. The hotter pot was allowed to bake only 8 minutes in the bin this time and we got metallic pinks at the base of the pot, and a ring of purple that would have done any triumphant Caesar proud appeared at the top.

"Still too cold!"

The third attempt hit it just about right with flashings of red, purple, pink, yellows, greens. Casey wasn't too satisfied, but we stopped him from a fourth firing — we had our own pots to fire.



Reducing in newspaper after taking the hot pot from the kiln



Casey Ginn's raku pot, purchased by the Suter Art Gallery, Nelson

OTAGO POTTERS GROUP

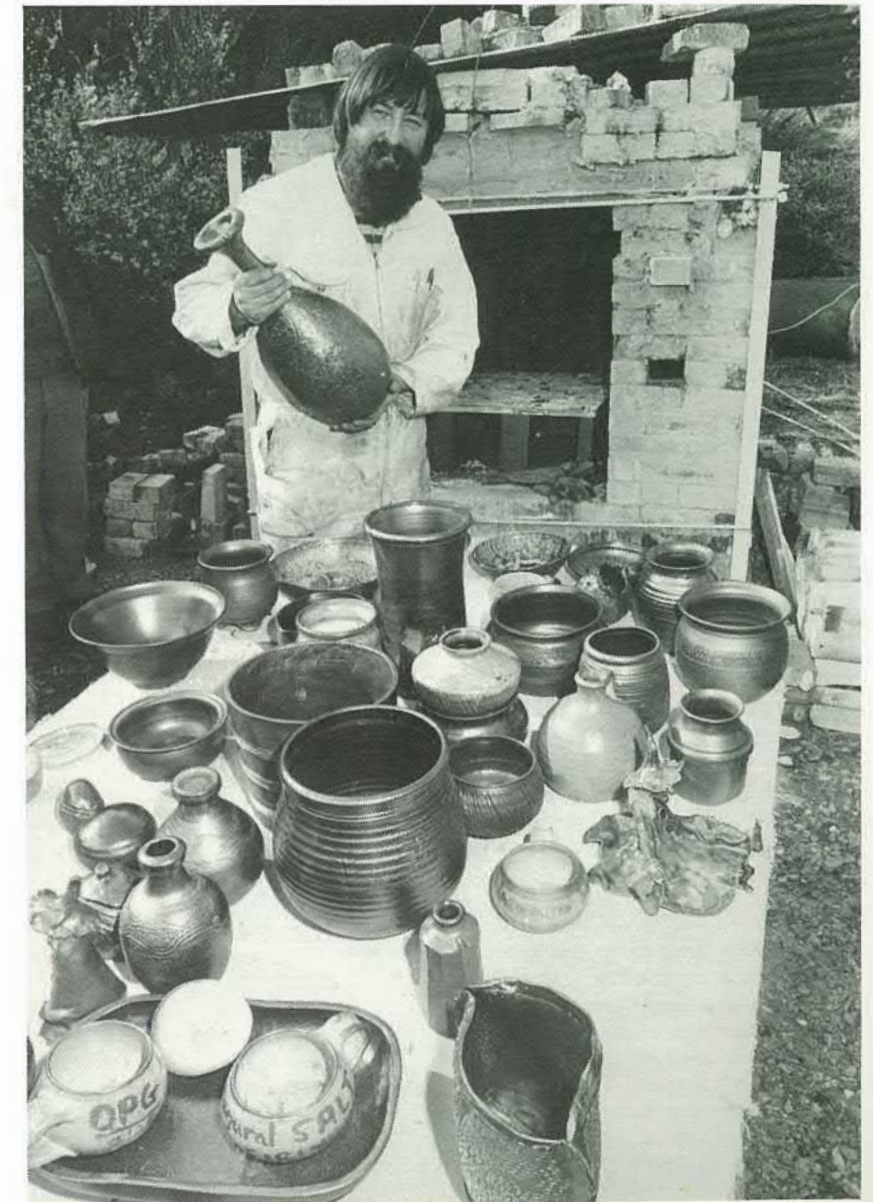

The vice-president of the *Otago Potters Group*, Ray Parker at the opening of the first firing of the group's new 25 cu ft oil-fired salt kiln. The 12 hour firing of 70 pots reached 1280°C, and used 12 kgms of salt to give a lightly salted effect.

Photo: courtesy of the Otago Daily Times

THE COLLECTORS

FORM, TEXTURE AND STYLE

By Don Long, Wellington

A year ago Denis O'Connor wrote in the *New Zealand Potter* "I can often relate to the people who buy my work because they've felt some sort of empathy ..." and John Glick has spoken of hearing from people who find a special pleasure "in their daily use" of his work and who "seem to clearly sense the enjoyment the making of it provided me." Throwing a pot can be so intensely private an experience that we forget that it is potentially an act of communication. But where does the work go? What are the reactions? We know why we make a piece, but what will someone be feeling about it after they've lived with it for many years?

In this article, the first in a series, we leave the familiar confines of the studio and follow the work out on a journey which takes us to those who find that special pleasure — that particular empathy — we all share with the objects we make with clay.

When the Viennese architect Ernst Plischke began designing houses for Wellington in the 1940s he brought a particular style of architecture to New Zealand: *Bauhaus*, or the *International Style*. A pupil of Walter Gropius, he built the home Betty and Dick Logan purchased three years ago.

At first sight it might seem the very antithesis of the hand-made. But the *Bauhaus* approach — that less could be more — that form should follow function — that simplicity of design could make aesthetic sense — underwent a transformation in New Zealand. As Betty perceives it, "in New Zealand the *International Style* became the one-off — *Bauhaus* became hand-crafted. "The Logans had found an already exquisite piece of architecture which could be enriched with art." Everything fits in. The house just displays pots. That was a consideration when we bought it. It has opened up possibilities for us ever since."

Perhaps it's the absence of clutter, of busy ornamentation which can so easily throw our appreciation for a work, which makes the Logan home such a pleasant experience. Plischke's smooth surfaces focus our attention on textures. That old pottery dualism of exterior versus interior breaks down as walls become windows. Rosemarie Brittain's birds for instance. Are they inside or out? Plischke makes us see it doesn't matter.

Pieces which are beautifully displayed in a gallery, sometimes hide their essence among all the details of our rooms. *Bauhaus* brings a different perspective. We are reminded of the architect Gerry Rippon's idea that, "the 20th century house should symbolise its own time and the lifestyle of its people." In this house the artistic languages of our period, so often kept mute, are allowed to be spoken.

"Texture and form interest us — and colour. They appeal to us most about New Zealand art. We buy pots so we can use them. It's this tactile sense; there's something living in the pots we use."

The Logans have owned more pots than they now have. They've given a lot to their children, and to friends. "We give pots for their birthdays," they told me. "Huge and beautiful pieces. Pottery offers a great deal more value for money than so many other things you can buy — though that's hardly the main consideration. In a small way we help support the potters we like."

Betty's interests in contemporary New Zealand art really blossomed when she became the exhibitions officer at the *Dowse* in the 1970s. From there she moved to *Foreign Affairs*, ultimately becoming their art curator. Now she operates an art consultancy business from their home in Wellington's eastern bays, advising corporations on their collections, a role which keeps her in contact with many of our best known potters. Betty and Dick's interests extend to fibre and painting. She is the New Zealand correspondent to the *12^e Biennale Internationale de la Tapisserie*.

They prefer buying from potters or exhibitions. "Too many people in craft shops can't talk about what they are selling. Uninformed sales people don't help the potters they represent. We care a great deal about the things we buy. People who sell the work should have an understanding.

"Is it important to them to know the potters themselves? They told me they enjoy sitting and talking while the potter gets on with his or her work. It isn't always possible. Betty is firm about one thing. "It's important that we support artists by buying their work."

We talked for some time about the pieces they have acquired over the years. Len Castle, noted for his surface treatment and delight in texture, attracted them for exactly these qualities. His relationship to natural forms through texture and shape, reminded me of his interest in the unglazed bowls of neolithic pottery. That set up a connection in my mind with the work Harry and May Davis have done in a village situation in Peru. Their work with Indian folk potters. "We wanted a classic *Crevenna* plate. And we enjoy eating off it." We discovered we share an admiration for the Davis' pioneering work in the Andes and here in New Zealand.

Betty had come to love David Brokenshire's anchor stone at the *Dowse*. Like Len Castle, there is this deliberate contrast between glazed and unglazed clay to reveal the underlying texture. Yet, when it's sculptural this can be so delicate and fine. We kept coming back to a discussion of texture.

"We have some plates by Mirek Smisek. We've always loved his work. We love the feel of it. As you pick them up they fit your hand. We always have this feeling 'this was made for this dinner'." Smisek has a passion for New Zealand's clays. In these plates this shows. The Logans have that rare gift of being able to take a true delight in a potter's domestic ware. Something which would please Smisek, who has often spoken about such things.

Graeme Storm intrigued them with his detail. I quoted his phrase of "a small miracle... that never dims with repetition." And the glazes achieved at high temperatures. His Finnish discoveries.

As we were talking I was taking photographs; rapidly losing the light. Behind us it filtered through the afternoon shadows of the bush. Was it here that Charles Heapy and Ernst Dieffenbach shot huia in the 1840s? In such settings I am always struck by associations — by connections. A large pot by Doreen Blumhardt set me to thinking of Africa, with its geometric lines touched with oxides. Here it is set out where it can catch the rain.

I thought of such affinities between things when we looked at the Brittain birds under the stairs. In this space

created by Plischke you are charmed by their silent presence. It's filled with light and they seem to exist solely in it. I'd read where Rosemarie has said, "I'm trying to follow through using birds for a starting point and work ... through a whole idea." You could see that happening here.

The light gave out before we could even begin to discuss so many others: Paul Fisher, John Parker, Neil Grant, Lawrence Ewing, Muriel Moody, Nicholas Brandon, Beverley Luxton, Jo Weissberg... I knew I would have to come back. There was so much I hadn't been able to capture on film.

We are so fortunate in New Zealand. In larger societies artists and the people who buy their work hardly ever meet. Here they become acquaintances and friends. With people like Betty and Dick you see the product of this — a wonderful enthusiasm for contemporary New Zealand art — of which pottery forms such a major part.



Len Castle: ash glazed bowl

Photos by Don Long

Len Castle: stoneware bottle



Jo Weissberg: plates with brushwork and glaze by Muriel Moody

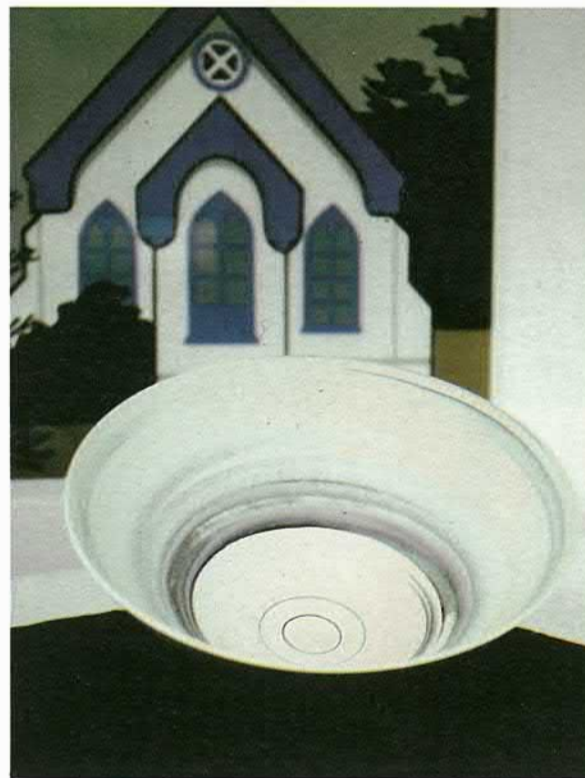

VENCO DE AIRING PUG MILLS

Same price as works sold in Australia

3" nozzle 6" barrel \$(Aus)1160
4" nozzle 8" barrel \$(Aus)2150

(Allow approximately \$(Aus)280 shipping to New Zealand payable when goods arrive in New Zealand port.)



G.P. & G.F. HILL PTY. LTD.
Manufacturer
VENCO PRODUCTS/WESTWIND TURBINES
29 OWEN RD., KELMSCOTT, WA 6111
AUSTRALIA
PHONE: (09) 399 5265

STRONG, SMOOTH HANDLING...SUPERB GLAZE RESPONSE.

Since its introduction into New Zealand, SC80 clay has proved to be one of our most successful products.

Its strong, smooth handling coupled with superb glaze response makes it the perfect clay for smaller, highly decorated ware.

This clay is moving fast, so place your order at your local stockist or:
Winstone
Potters Clay,
P.O. Box 3,
Nelson.

SC80
WINSTONE
QUARRIES LTD
WST 287 OGILVY



NEW VISION CERAMIC ARTS

Philip Luxton Exhibition

Gt. Northern Arcade
45 Queen Street
Auckland 34149

Clay Sculptor in Ranfurly

Ngarie Mulholland is a housewife whose family is grown up, giving her time now to work with clay, mostly using slabs and coils.

She uses stoneware clays, *RMK II* and *GB II*. Recently she tested and fired an overburden clay from a local open cast lignite mine. This clay dries white, bisques to a cream colour and glaze fires at the same temperature as her other bought clays. It is excellent to model with.

The pieces are bisque fired to 960°C, glaze to 1280°C, allowing a one hour soak on glaze firings in an electric kiln.

Oxides are used to show detail markings with different colours, and a flowing clear glaze used over, under, or in between other glazes. Glazes are sprayed, poured or brushed on, depending on the particular piece.

Ngarie works in her home and also at the *Maniototo Pottery Club* in Ranfurly, Central Otago, where she has been a member for 8 years.

'Fawns', stoneware, 35 cm long
Photo by Thomas Mitchell



NZ Potter in Canada

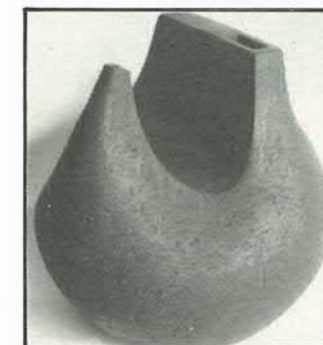
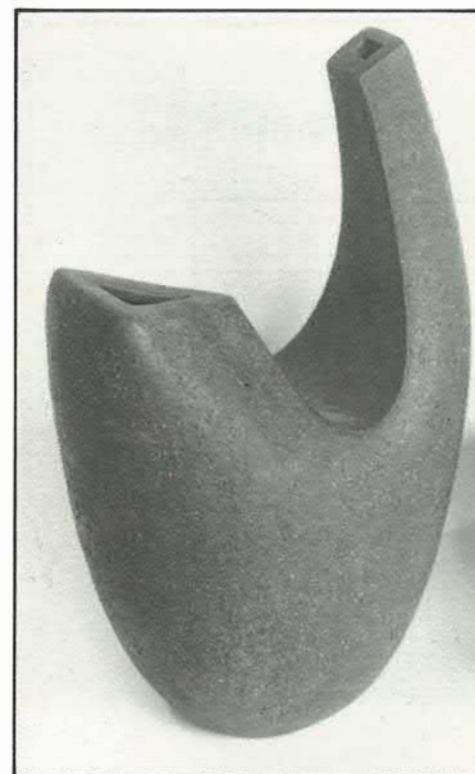

An Auckland potter, Glenys Marshall-Inman has now been living and potting for 7 years at Bragg Creek, a small village 20 miles from Calgary, Canada.

Pictured are 2 of her recent sculptural pots and her studio. Calgary's winter sometimes means loading the kiln in temperatures as low as minus 20°C. Bragg Creek is a very beautiful area and has attracted many artists and craftspeople to live there.



AUCKLAND STUDIO POTTERS 21ST ANNUAL EXHIBITION 1985

Auckland War Memorial Museum Selector, Brian Muir

Photos by Howard Williams and Ces Thomas



Guest Exhibitor, Marilyn Wiseman: slab boxes of white stoneware, slip decorated and wood fired

Chris Cockell: Neon Spheroids, low fired



NEW ZEALAND POTTER No.1, 1986



John Crawford: porcelain bowls, on-glaze enamels



Carol Swan: Bags of Sweets, porcelain

Peter Lange: slip cast teapots



NEW ZEALAND POTTER No.1, 1986

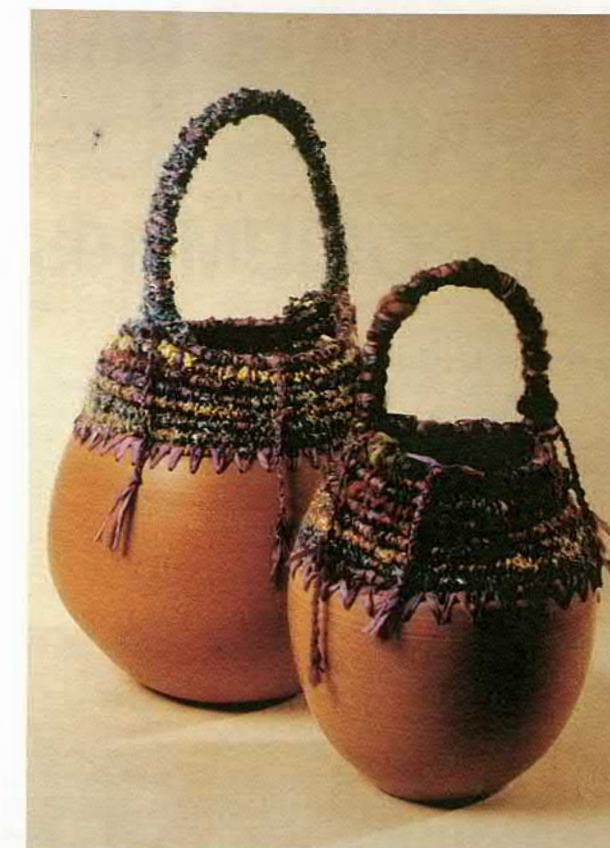

Christine Purdom: Basket Forms, earthenware and wool

Andrew Thompson: matt glazed stoneware teapot



45

INTERNATIONAL CERAMIC SYMPOSIUM 1985

By Royce McGlashen, Nelson

The 1985 International Ceramic Symposium was opened on the 4th of August at the *Appalachian Centre for Crafts* at Smithville, Tennessee — 1¼ hours from Nashville. The Centre is operated by the *Tennessee Technological University* at Knoxville.

The opening and welcoming ceremony was addressed by various people representing the *University*, the *Appalachian Centre* and the *International Symposium* committee and they all expressed an eagerness to see what would be created in the following 4 weeks by the 18 attending ceramic artists, who were chosen from 13 countries. I felt honoured to represent New Zealand having been invited after my name was submitted by the *NZ Society of Potters* and I had sent my curriculum vitae and a selection of slides.

The first morning was spent meeting the workshop manager and the other symposium organisers, plus a trip around the centre to locate clay, raw materials and any equipment we might require. There were no limitations on size, materials or firing methods and none of the interruptions that occur in one's own workshop.

It takes time to become familiar with new materials and firing systems, so I started by making a few straight forward pieces to familiarise myself with everything — and getting to know the people. Perhaps half of the time was spent talking to the other artists about techniques, particular effects and the direction of their work. Most of these people were established artists with definite ideas, theories and experiences, providing very valuable resources for discussion.

With the help of my assistant — there were 10 studio assistants who worked extremely hard to aid the 18 artists — I was able to test the clays and the American conversions of my glazes. I test fired after two days with pleasing results from the coloured pigments.

This was an opportunity to spend time on individual pieces that I had long had in mind — but not the time to create at home. I particularly wanted to concentrate on using sulphates on a white or porcelain body and to explore my interest in the teapot form. To use the teapot shape as a sculptural form often non-functional. I wanted to vary my construction techniques, mainly using a vessel thrown without need for turning — round, but casual in appearance. The handles and spouts to be sculptural additions as opposed to functional. As the surface decorations were to be important the shapes needed to be clean and smooth.

Every Wednesday evening the *Appalachian Centre* was open to the public and extensively advertised on radio and in newspapers. Between 70-100 people attended each week to see slide presentations and to view the works in progress. Each week 5 artists had 30 minutes each to present their country, their own work and the work of others. These were interesting evenings generating much discussion among the ceramic artists and assistants who talked in depth about what people were creating at home, plus the general attitude of their society to ceramics.

It made me realise how buoyant the New Zealand market is and how enthusiastic our public and media are toward craft. We have generated this interest and we should not become complacent about the public's attitude. Most of the ceramic artists considered there has been a change in the last 5 years away from the Leach/Hamada tradition to a more sophisticated area. It is a challenge we must accept to include the public in what we are doing, to nurture their interest in our new developments.

Each weekend we were taken on a bus trip, the first being to Nashville. We left early for a breakfast reception in Franklin at a gallery called *Windows on Main Street* where we were hosted by clay artists and gallery owners. We



Royce McGlashen

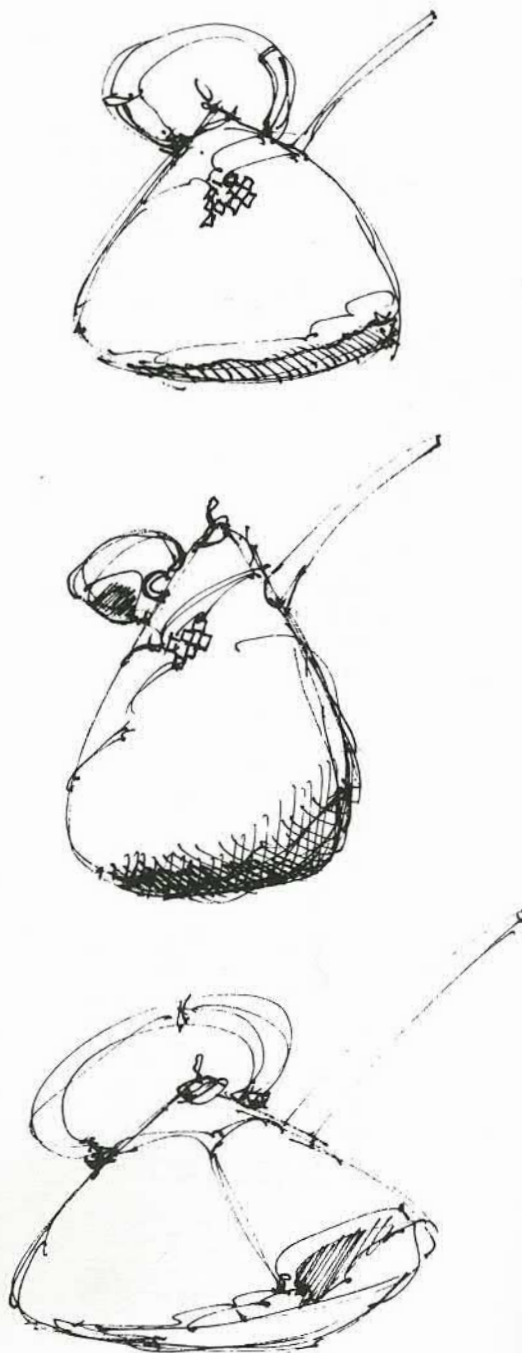

Photos and drawings by Royce McGlashen

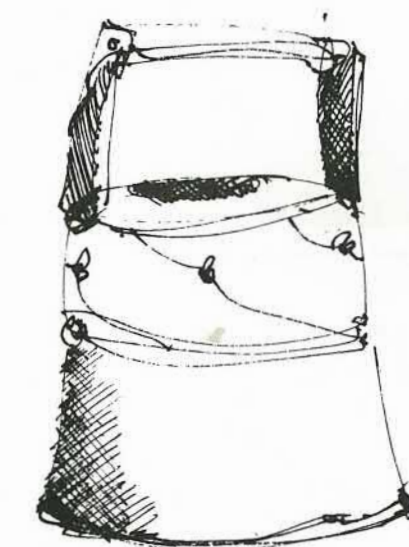

Thrown teapot form. Copper sulphate



Royce will be showing slides of this trip at the NZSP conference in Christchurch 16th to 18th May.

met local artists, saw their work and recent works by the North American symposium delegates. Then to Nashville to visit galleries and museums where we saw works from past symposia, collections of American ceramics and works from the Nashville area. We finished the day at the *Zimmerman-Saturn Gallery* attending the opening of a ceramic exhibition — a very warm reception and a fine meal with local wines. A pleasant climax to a long day.

The second week saw people getting down to serious constructions. I concentrated on my teapot shapes and other thrown pots. By this time people were considering how they would fire their pieces and how kilns could be used to their maximum. Some were using their traditional materials and methods, others were experimenting with new ideas and methods.

The middle weekend was an overnight trip to Knoxville and Gatlinburg on the eastern border of Tennessee State. At the art department of the *University of Tennessee* we met the instructor Jim Darrow, saw an exhibition of the students' work, then visited an experimental ceramic experience where a number of young artists exhibited many different techniques using ceramic materials, or presentations of those materials. We proceeded to *Arrowmont School of Craft* where we stayed overnight. On Sunday we travelled to Gatlinburg, the Great Smokey Mountains National Park and the Cherokee Indian Reservation.

In the third week we began to see pieces completed, despite the many weather changes, from extremely hot clear days, to foggy high humidity with associated drying problems.

The last weekend was a one-day trip around the local Cumberland Mountain area, visiting studios in-

cluding Mary Ann Fariello, clay artist; William Rodgers, blacksmith; Eileen End, fabric artist; Jack Hastings, sculptor of carved concrete — plus local craftspeople making brooms and a 3 generation family of chairmakers. Our last stop was at *One Mountain Gallery* at Cookeville where we were entertained by a country music band — very lively.

The final week was hectic with people glazing, finishing and firing at strange hours. Most of the kilns were gas operated updraft, some fan-blown gas-fired downdraft, a large range of electric kilns, wood-fired kilns and special effects kilns using salt vapour and sawdust-fired. It was interesting to see how people handled different firing systems and fuels. The results were not always as you would expect which can be disappointing when there isn't time to start again.

The assistants were tremendous and it was interesting to share a younger generation's ideas, admirations and their feelings on the developments and changes for the future.

All the pieces created at the symposium were the property of the *Tennessee Technological University* with a selection being made for an exhibition to be held at the *Appalachian Crafts Centre* for the month following. Two pieces of work by each artist were also selected, one each for the permanent collections of the *Tennessee Technological University* and the *Tennessee Museum*. The remaining pieces could be left for sale in the *Craft Centre* gallery or taken to other galleries for sale.

On the final Sunday we made our fond farewells. It had been a wonderful experience for me. I would like to thank the *NZ Society of Potters* for nominating me and the *QE II Arts Council* for the travel grant covering the fares to Tennessee and return.

Thrown box/bowl. Overglazed and brush decorated

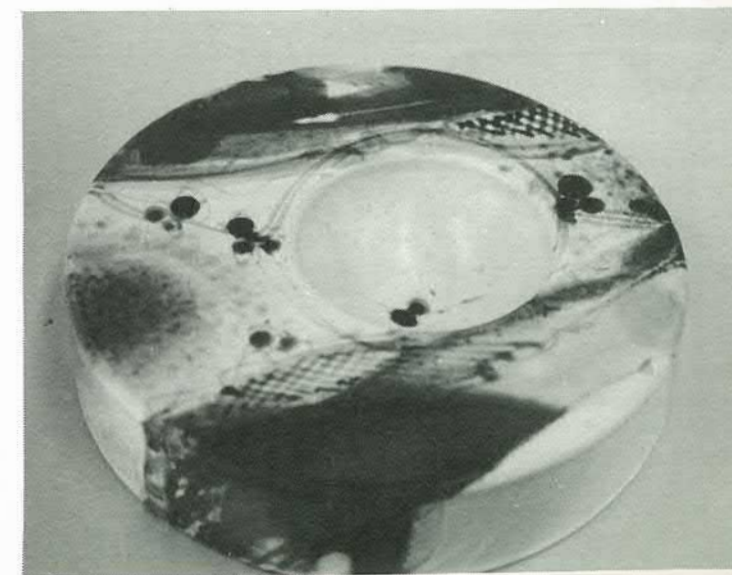

BEYOND CRAFT NATWEST ART AWARD 1985

NZ ACADEMY OF FINE ARTS, WELLINGTON

This exhibition comprised 245 works by 122 artists, and included paintings, weaving, quilts, embroidery, batik, hot glass, jade and bone carving, metalwork, sculpture and pottery.

The \$1000 awards were taken by West Auckland painter **Ilsa Posmyk** for her tiny oil paintings, and by Auckland potter **Keith Blight** for his group of monumental slab pots, *Impressions of Nature*.

NATWEST AWARD "BEYOND CRAFT" 1986

Receiving day — 9 September
Exhibition — 5-19 October
Write now for entry forms to:

NatWest Award
NZ Academy of Fine Arts
Private Bag
Wellington.



Keith Blight, Auckland, Winner NatWest Art Award 1985

W.D. MCGREGOR LIMITED



BTU-TIFULLY EFFICIENT

That's how you sum up the new range of McGregor LPG Gas Fired Pottery Kilns. Sizes range from 6 cubic foot upwards. All are designed to operate at 1350°C.

McGregor Gas Fired Kilns are the only true downdraft kilns available to New Zealand potters and have been given full approval by both local and overseas experts in this field.

Other features include:-

- ★ Excellent temperature uniformity
- ★ Uniform reduction easily obtainable
- ★ Flame safety equipment as standards
- ★ Brick portal, base and flue
- ★ Stackbonded fibre insulation
- ★ Slide damper
- ★ Economic performance
- ★ Twelve month guarantee

Optional extras include:-

- ★ Electronic temperature controllers
- ★ Kiln programmers
- ★ Metal flue extensions

Other features include:-

- ★ Low mass insulation
- ★ Low cost - long life elements
- ★ Minimal maintenance
- ★ Long life element support
- ★ Base shelving
- ★ Door safety switch
- ★ Twelve month guarantee
- ★ Castors on base

Optional extras include:-

- ★ Electronic temperature controllers
- ★ Kiln programmers

CHOSEN BY EXPERTS

McGregor Electric Kilns - made to the standard you have come to expect from the professionals will give years of workability and reliability. McGregor kilns are based on years of experience coupled with modern age technology which makes them so easy to control. McGregor kilns are available in composite brick fibre construction which cuts firing costs but maintains a high standard of production and results in the finest kiln money can buy.

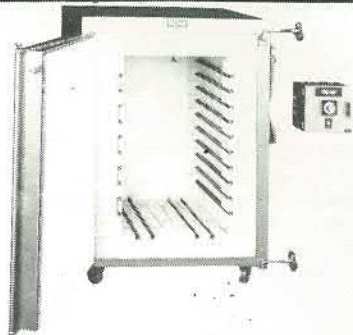

McGregors' expertise is at your service should you require a kiln of special size or specification

"START WITH QUALITY TO END WITH QUALITY"

McGregor

New Zealand's foremost supplier of Gas and Electric Kilns
Manufacturers of: Replacement elements for all types of Pottery Kilns, using Kanthal A1 wire
Suppliers of: Kiln shelves, Silicon Carbide and Sillimanite Kiln Shelves and castellated props

118 Stoddard Road, Mt Roskill, Auckland 4.
Phone 699-619. Telex NZ60192 WDMG

EXHIBITION CALENDAR

Auckland War Memorial Museum
April 21 - June 2. Peruvian Gold
June 1 - 15. Fletcher Brownbuilt Pottery Award
June 28 - July 13. Philips Studio Glass Award

Albany Village Pottery
June 7 - 18. Nelson Potters; Peter Gibbs, Royce McGlashen, Steve Fullmer and Christine Boswijk
August 10 - 20. Rick Rudd, raku

Compendium Gallery, Devonport
April 20 - May 3. Leonie Arnold, porcelain dolls and Daniel Clasby, silver sculpture and jewellery
May 4 - 18. Show of the Century. Devonport Centennial Exhibition, pottery by Andrea Barrett, Penny Evans, Campbell Hegan, Sue Lorimer, Michael Lucas, Jill Totty, Diana Poor, John Robertson, Andrew Thompson, Sally Vinson
* September/October. Annual Pots for Plants exhibition. Potters interested in participating should contact Compendium Gallery, 49 Victoria Road, Devonport.

Pots of Ponsonby
May 5 - 17. Megan Biss and Aldeth Nevin, Ikebana
May 24 - June 7. Winter Dialogue No.1. Chris Mules, potter and Roger Mortimer, printmaker
June 21 - July 5. Winter Dialogue No.2. Helen Pollock, potter and Bernard Schofield, photographer
July 19 - August 2. Winter Dialogue No.3. Robin Paul, potter and Helen Schamroth, fibre artist.
August 16 - 30. Winter Dialogue No.4. Christine Purdom, potter and Ken Scott jeweller

12 Potters, Remuera
May 4 - 17. Colour Bold and Bright, invited potters
June 1 - 14. Very Black and Very White, invited potters
July 6 - 19. Bette Heising quilts, and lamps by members
August 10 - 23. Domestic with a Difference

Gallery 242, Hastings
June 16 - 27. Peter Collis, decorative stoneware
July 14 - 25. Beverley Luxton, porcelain
August 11 - 22. Anneke Borren, pottery and Owen Mapp bone carving, with combined pieces

NZ Academy of Fine Arts, Wellington
April 13 - 27. BNZ Art Award. Pottery, prints, sculpture and photography
May 25 - June 8. BP Art Award. Painting and Wall Sculpture
July 6 - 27. ANZ Bank Art Award. Fabric and Fibre

Van Helden Gallery, Days Bay
April 23 - May 2. All Stars Peter Shearer and Peter Collis. We Aim To Please, pottery exhibition

The Villas Gallery, Kelburn, Wellington
July 6 - 18. Muriel Moody, pottery, Hugh Bannerman, rugs
August 3 - 15. Gail Sammons, pottery
August 31 - September 12. Philip Luxton, pottery with selected works from well known NZ potters

Wellington Potters Shop
May 10 - 17. Paul Winspear, domestic ware
June 21 - 29. Winter Solstice. Members' pottery
July 26 - August 2. Judith White, Spring flowers and related containers
August 23 - 30. Craig Hall, domestic ware.

POTTERS MARKET

POTTERY CLASSES

FROM beginners to advanced in 12 week blocks, private tuition, studio rental on long term basis. PETER COLLIS POTTERY WORKSHOP. Write 31 Tizard Road, Birkenhead, Auckland, to tel: 489-856.

"BOOKS"

'STONEWARE GLAZES — A Systematic Approach' by Ian Currie. See reviews in Dec.85 editions of 'N.Z. Potter' and 'Pottery in Australia'. \$A28 per copy postage paid to N.Z., or bulk orders of 9 copies or more at \$A22 each. Available from: Ian Currie, North Branch Pottery, Maryvale 04370, Australia.

POTTERS MARKETS

AUCKLAND POTTERS — Non Stop Pottery Entertainment, Sunday June 8th. Nelson potters Royce McGlashen, Christine Boswijk, Steve Fullmer, and Peter Gibbs present a packed day of Ceramic excitement. Demonstrations, slides, discussion, glaze recipes, firing techniques at a variety of temperatures, hints, problem solving. Lunch and Nelson beverages provided. All-inclusive price \$15. Register now: Nelson Potters Workshop, Rangitoto College, N.S. Postmens Sorting Centre, Northcote.

EXCHANGE

EXCHANGE for one year large pottery workshop, three bedroom home in Kaeo, for similar near city. Write, Barron, P.O. Box 29, Kaeo.

WANTED

WHITE horse pottery replacement pieces. M. Walker, 1 Burcham Street, Lower Hutt.

GALLERIES

WARKWORTH TOWN POTTERS, Baxter Street, Warkworth. Open daily from 9. Tel: (0846) 8790.
KILN SHELVES. 24 x 13 Silicon Carbide, good condition. 30 @ 65 each or \$2,000 the lot. Enquiries: Steve Yoeman, 41 Dickens Street, Auckland 2. Tel: 788778.

FOR SALE

REMARK front-loading rigid fibre kiln, LPG fired. 24 cu ft internal capacity. Brand new; manufacturer's guarantee carried over to new owner/s. Price \$5,500. Sale for health reasons. Enquiries to Chris Jukes, 18 Wordsworth Street, Cambridge.

For the best of
the crafts
subscribe now to

NEW ZEALAND

Crafts

You will receive 4 issues a year plus regular newsletters
and free membership to the Crafts Council of New Zealand

Please send me NEW ZEALAND CRAFTS
I enclose a cheque for NZ\$30.00

Name _____

Address _____

Mail to Crafts Council of NZ, P.O. Box 498, Wellington 1, N.Z.

WESTERN POTTERS SUPPLIES

AUCKLAND

Clark St, New Lynn
Ph 873-479
877-350

HAMILTON

Northway St, Te Rapa
Ph 497-473



- ✓ New McSkimmings pottery clays
- ✓ Winstones pottery clays
- ✓ Colour range, pottery stains, bulk stocks
- ✓ Western Potters white earthstone clay
- ✓ Western Potters white casting slip
- ✓ Air brushes and spray systems
- ✓ Onglaze enamels — golds — lustres
- ✓ China painting materials
- ✓ Ceramic fibre kiln building materials
- ✓ Kiln furniture — shelves — props
- ✓ Books — batts — spigots — corks
- ✓ Wheels — electric kilns — machines
- ✓ Press moulds — plasters
- ✓ Monthly accounts

AT LAST!
the time has come

*We have always
been the best . . .*

*. . . now we are
the cheapest!*



\$720

Whether you pot for a living or simply for pleasure, you want a wheel that's reliable. The Arum electric wheel is your answer. There are no complicated tyres or cones to go wrong in the Arum wheel. Its simple construction and its low voltage thyristor drive means the Arum wheel will give you reliable service for life.

Please write for information:



**arum
PRODUCTS**

142 Eastern Hutt Road
Taita
LOWER HUTT

PO Box 30-349
Lower Hutt
Phone 672-688



**ANTIPODES
GALLERY**

Bill & Pauline Stephen — Directors

Features:

- ★ Hand thrown pottery
- ★ Handblown glass
- ★ Hand turned woodware
- ★ Hand fashioned leatherware
- ★ Jewellery — sterling, brass, bone and copper

5000 sq ft to browse through.
Cnr Taranaki & Dixon Streets, Wellington
Phone 851-801

N.Z. SHIMPO AGENT

SHIMPO WHEELS AND PUGMILLS
AND ALL POTTERS SUPPLIES

AGENTS FOR

- TALISMAN
- COBCRAFT
- POTCLAYS
- WINSTONES CLAY
- McSKIMMINGS
- POTTERY BOOKS

WRITE FOR FREE PRICE LIST, MAIL ORDER
HOURS 8.00-4.30 SAT. 8.00-12.00

COASTAL CERAMICS

124 RIMU ROAD PARAPARAUMU N.Z.

PH. 058-84377

WHICH KILN SUITS YOU ?

**Both the same
size - but
different designs**

PERFORMANCE
Both fire to 1300° in a fast economical three hour cycle — or as slowly as you desire, with a guaranteed evenness of 10°. Both achieve even reduction or oxidation atmospheres.

BURNERS
Both have two burners — each with individual gas control and preset primary air supply — no other system is as simple to operate.

INSULATION
Both are lined with 'Rigid Ceramic Fibre' — the best type of pottery kiln lining (no fluffy blanket falls on your ware) Rigid fibre is better able to take the knocks — a Rexmark exclusive. N.Z. Patent No. 19381.

TRAINING
For both we offer full training — Set up — Stacking — Firing — Safety and maintenance. Essential for the new potter but equally valuable for experienced potters.

WARRANTY
Both have a twelve month warranty but more important is our unmatched after sales service — we stand behind our kilns even after the warranty period.

ENQUIRE FURTHER FOR OUR RANGE OF
PRODUCTION KILNS — From 6 to 60cu.ft.



ROBUST PRODUCTION MODEL

Heavy steel frame — Baked Epoxy coated with 'Breathing Panels to disperse water vapour.

FRONT LOADER — TWO LARGE SPY HOLES —

CHOICE OF INSULATION THICKNESS:

80mm — 6 to 8 hours optimum firing cycles

100mm — 8 hours plus cycles

RMD 6.0/ 80mm — \$2295 complete

100mm — \$2345 complete



PORTABLE LIGHTWEIGHT MODEL

Aluminium frame with lightweight breathing panels
Transport weight only 35kgs — fire anywhere without a flue then back into storage

TOP LOADER — ONE LARGE SPY HOLE —

INSULATION THICKNESS — 55mm

Optimum firing cycles — 4 to 6 hours

N.Z.'s LOWEST PRICED 6.0 cu.ft KILN

— \$1535 complete

Also available

N.Z.'s LOWEST PRICED 3.6 cu.ft KILN

— \$1095 complete

REXMARK DEVELOPMENTS LTD

58 Athens Road, Onehunga, Auckland. Phone 643-311
(Previously 663-311) anytime except Thursday and Friday

"THE GAS KILN SPECIALISTS — WORKING
EXCLUSIVELY WITH STUDIO POTTERS"

buying a pottery kiln? COMPARE THESE WITH OTHERS

FROM US YOU BUY AN ASSET NOT A LIABILITY

Ask our customers — come and consult us

WE OFFER YOU

- A twelve month unconditional guarantee on materials and performance.
- Kilns are designed by qualified furnace designers.
- A New Zealand wide installation and maintenance service.
- Any type of kiln, top loading, front loading, truck, tophat, elevator and tunnel kilns, from 0.1 to 1000 m³ gas, electric and oil firing to 2000°C.
- A complete advisory service on ceramic processing.
- Kiln shelves and furniture — industrial grade E.C.E., Drost, Royal Sphinx, Koppers-Dynamidon, Annawerke.
- Electric potter's wheels, pugmills, filter presses, and other industrial clay processing machinery.
- We manufacture pyrometers and kiln programme controllers and supply all leading brands of imported controllers. Sole agents Sigma controls.
- We manufacture and design spare elements for any brand of kiln at low cost, 24 hour service.
- Low thermal mass ceramic fibre lined kiln for fast heating and cooling giving low firing costs.
- NZ Agents for Sigma Controls Japan

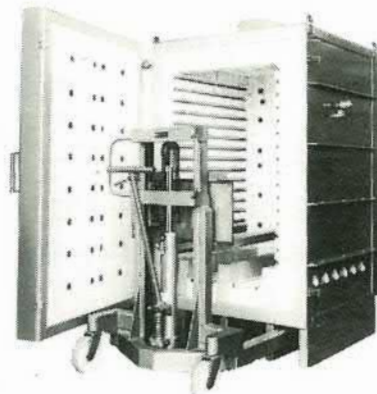

Fork lift loaded kilns



Top loading kilns
5.1 and 3.5 cu.ft.

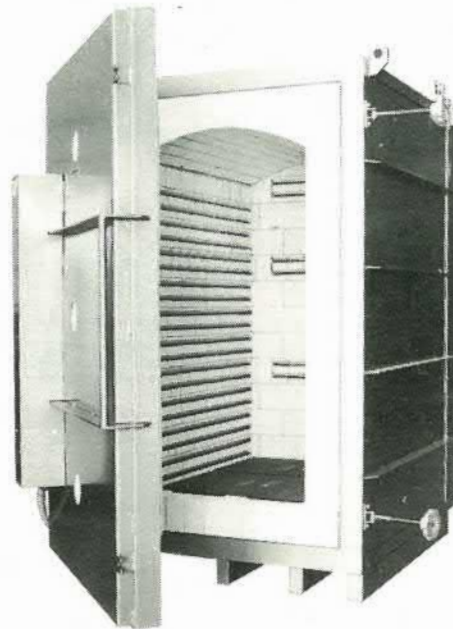

Front loading kiln 40 cu.ft.

elecfurn® the electric furnace co ltd

73 Wiri Station Road, Manukau City, Auckland
PO Box 76-162 Manukau City, Auckland, New Zealand

Telephone 263-8026
Telex NZ60017 MORTCO

HIGH QUALITY ACCESSORIES FOR THE CERAMIC INDUSTRY

- from U.S.A. ★ GRIFFIN GRIP and LIDMASTER
- Netherlands ★ ROYAL SPHINX REFRACTORIES Perforated and solid kiln shelves.
- West Germany ★ DECORATING GOLD & LUSTRES
- ★ CERAMIC TRANSFERS, world's largest range.
- ★ ARTIST'S BRUSHES for all ceramic purposes.
- Italy ★ UNDER— and OVERGLAZE CERAMIC TRANSFERS.
- and last but not least, from New Zealand the AMBIDEX BANDING WHEEL and CUSTOM MADE DECALS FOR YOUR POTTERY.

Where not available from your usual supplier, contact the importers and distributors

CALL: 152 Greenlane Road, Greenlane, Auckland 5
TELEPHONE: (09) 542-386 or 545-743
WRITE: P.O. BOX 17-191, Greenlane, Auckland 5.
CABLE: CERADEC-AUCKLAND TELEX: 2553-CERADEC AK/NZ

AFFILIATED INDUSTRIES LTD.



THACKWOOD Pottery & Gallery

Highway 6,
Wakapuaka
Nelson Ph. 520-978
Open Mon-Sat. 10-5.

Potters:
Ross Richards
Carol Crombie
David Wilson
Adrienne Richards

Southern Ceramic Import Co. POTCLAYS LTD

STOKE-ON-TRENT

- Clays
- Glazes
- Tools
- Kilns
- Wheels
- Kiln Shelves
- Raw materials

Mail orders welcome:
Catalogue available from:

Mona Bush, No. 1 RD, Invercargill Telephone (021) 394-875

Hadfield & Youngson Clay

DENYS HADFIELD & JOHN YOUNGSON

INTRODUCE NEW WHITE STONWARE CLAYS IN POWDER FORM TO GIVE UP TO 25% MORE CLAY. ADD YOUR OWN WATER AS REQUIRED. — EASY TO USE — EASY TO STORE

Blended Dry White Stoneware Body.

QUALITY WHITE & LOW FIRING WHITE

Quality White:
\$500 per tonne
\$13 per 20 kg bag

Plastic, Low Shrinkage,
Firing Temperature
1250-1300°C, Fires White.
Super Fine Finish.
Intensifies Glazes.

Low Firing White:
\$425 per tonne
\$11.50 per 20 kg bag

Firing temperature
1200-1250°C.

Smaller quantities also available from:

H. & Y. CLAY,
42 Mathias St,
DARFIELD.

MOTHER'S DAY

Why not thrill her with the ideal gift — a year's subscription to the



NEW ZEALAND Gardener

will delight her for the next twelve months!

You can also give a presentation binder to keep the issues in perfect order. Simply post the coupon below. With the first issue sent, we'll include a gift card on your behalf.

To: New Zealand Gardener
Subscriptions Dept., Private Bag, Petone.

I enclose my cheque for \$.....
One year's subscription (11 issues) \$28.50 including GST
One year's subscription with binder \$37.70.

Recipient's name: Your name:

Address: Address:

WEST RIDGE POTTERY

HONEY VILLAGE, TAUPO

Resident Potters:
Irwin and Raewyn Lawson
Wayne and Sue Porteous

Finest Quality New Zealand Pottery
Telephone 83925 Taupo

FOR \$85.00

**This space could be
selling for you**

Contact
Advertising Manager
NZ Potter
Private Bag, Petone
Ph (04) 687-179

Ask for our advertising Rate Card

The Palms Gallery

WAYBY

A fine selection of
New Zealand Crafts

TURN LEFT 500 METRES OFF STATE HIGHWAY 1
15 km NORTH OF WARKWORTH

OPEN 7 DAYS 9.00 - 5.30 pm
PHONE (08463) 7125 RD 6 WELLSFORD



Peter Collis Pottery Workshop

- Beginners to Advanced classes.
- Long term studio space and Tuition.
- Summer and weekend schools.
- Peter Collis Studio Pottery.

31 TIZARD RD. BIRKENHEAD POINT AUCKLAND 489-856



Pottery
Screen Printing
Paintings
Leathercraft
Basketry
Weaving
Jewellery

Specialising in Garden Pottery

Pat & David Boyes
P.O. Box 120, Phone: 48526

EASTERLEY

The Cottage Craft Shop

Ocean Beach Road
Tairua, N.Z.

Ann Ambler
John Anderson
Mary Hardwick-Smith
Barbara Hockenhill
Barry Hockenhill
Peter Lange
Renton Murray
Peter Oxborough
Heather Skeates
Robyn Stewart
Peter Stichbury
Margaret Symes
Howard Williams
Marilyn Wiseman
Andrew Van Der Putten

Ph. 4159-403

Open 7 days 9 am-5.30 pm

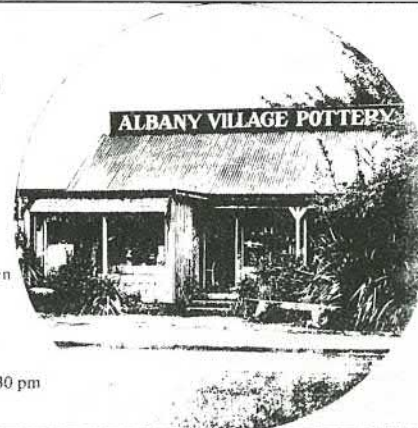

"Connoisseur"

New Zealand Handcrafts —

*Pottery, Porcelain, Bone, Leather,
Jewellery — also Paintings by talented
New Zealand artists*

Shop 42 BNZ Centre 1 Willis Street
Wellington Telephone 735-560

THE OLD TUA MARINA STORE

EST-1905
Jan & Gerald Hope,
R.D.3 Blenheim, N.Z.
Telephone 685. Spring Creek.

VISIT HISTORIC TUA MARINA
We supply wholesale to
Craftshops and Galleries

8 miles North of Blenheim, State Highway 1 Blenheim/Picton

the Villas gallery

*NZ's top art workers are
invited to exhibit*

Exhibitions monthly

Only exhibition stock on sale

HOURS: MON TO FRI 10.30 am to 4.30 pm
SAT 10 am to 1 pm

The Villas at Kelburn, 87-89 Upland Road, Wellington 5
Telephone 757-943



FIRE & FORM

POTTERS CO-OPERATIVE SOC. LTD.
CHARTWELL SQUARE HAMILTON PH. 56638

Large range of pottery
from ten Waikato Potters.
Monthly exhibitions.

Open Monday-Saturday

HERE'S GOOD NEWS

**PREVENT CRACKED
OR WARPED POTS**

*To be sure glaze is dry between
coats when brushing.*

**THE 'BEEPER' DAMPNES
INDICATOR WILL TELL
YOU WHEN YOUR POTS
ARE REALLY
DRY AND
READY TO
FIRE**

\$25

POST FREE
ANYWHERE IN N.Z.



MANUFACTURED BY:

J.K. POTTERIES

P.O. Box 19582 Woolston Christchurch
Ph.841-328

**DON'T
PUT IT OFF
PLACE THAT
CLASSIFIED
NOW**

contact JOHN DEAL (04) 687-179

CLASSIFIED ORDER FORM

Your classified advertisement will be seen by the people you want to reach. Send your advertisement today by filling out the form below.

Advertisements will be charged at 50c per word with a minimum of 10 words.

Display rate: \$85.00 per issue for advertisement size 1/8 page (60mm deep x 85mm wide). Other size display rates available on request.

Place my advertisement times beginning in the issue.

Enclosed is my cheque for \$

NAME

ADDRESS

SIGNATURE

My advertisement is to read as follows:

Please send your classified advertisement to:

Advertising Manager
NZ Potter
Private Bag
Petone

MAC'S MUD COMPANY



Redwood: Very plastic, easy to throw, low shrinkage 5-6% to dry, 13-14% overall. Fires to cone 9-10. Dark grey [R]

Redwood Coarse: Very plastic, good for slabs, large pots and salt glazing. Low shrinkage 5-6%, to dry 12-13% overall. Fires to cone 9-10. Grey [R]

Waiwhero: Very plastic, good for slabs, large pots and salt glazing. Low shrinkage 5-6%, to dry 12-13% overall. Fires to cone 9-10. Light grey [R]

Planter Body: Plastic, coarse, easy to throw, good for planters and outdoor pots. Low shrinkage 5-6%, to dry 13-14% overall. Fires to cone 9-10. Toasted brown [R] red [OX]

Porcelain: Very fine plastic throwable porcelain. Translucent. Cone 8-10. Shrinkage 5-6%, 13% overall. Translucent. White [R] & [OX]

pH level of all these clays 4. All these clays are used at Cob Cottage Pottery, Brightwater.
Clay: Tonne lots \$320.00, 25kg bags \$8.50, 8kg bags \$3
Porcelain: 25kg bag \$26.00, 8kg pack \$9.00



Royce McGlashen

128 ELLIS STREET, BRIGHTWATER
Telephone 23-585



We dig and blend
the finest
West Coast clays

CHASH CREEK Fires to cone 7 - 8 reduction.
Improved plasticity and drying properties.

BULLER STONEWARE Fires to cone 9 - 10 reduction.
Good domestic body.

Enquiries welcome

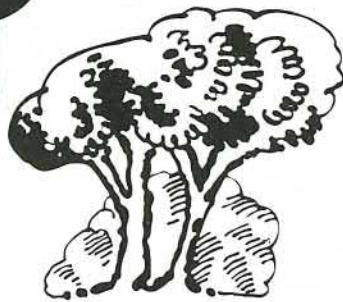

New Zealand Craftworks

We stock only the best presented work from the widest range of Potters and Glass Blowers in New Zealand. This is our buying philosophy and we believe we are achieving it.

New Zealand Craftworks

P.O. Box 68 Tuesday-Sunday
Te Horo and public holidays
Phone Otaki 43175 10.00 am-5.00 pm

When in Lower Hutt
visit Penny-Farthing Gallery

We stock only
New Zealand-made Arts and Crafts

PENNY-FARTHING



DUDLEY STREET LOWER HUTT PHONE 699-826

The Old Dairy Factory Pottery Crafts

Sheepskins
Souvenirs



Shirley & Bert Bartlett

OPEN 7 DAYS

Mon-Thurs 10am to 5pm
Fri-Sat-Sun 10am to 6pm

Station Road, Waimauku Village
25 minutes drive from city. Opposite
Muriwai turnoff. Ph. 411-8665 Auckland



An Alternative To Asbestos

Nomex® Gloves, Mitts, Aprons, and Blankets



Permanently Flame Resistant
Will not melt or drip
Long wear life
Comfortable to wear

Manufactured by Raltex Division Sunbeam NZ Ltd
PO Box 9542, Newmarket, Auckland.
Phone: 399-747

For more information on these products please refer
to NZ Potter Magazine No. 1 1984 Page 14
Available from most major pottery supply houses
and safety equipment suppliers throughout
New Zealand.

the wheel of the future

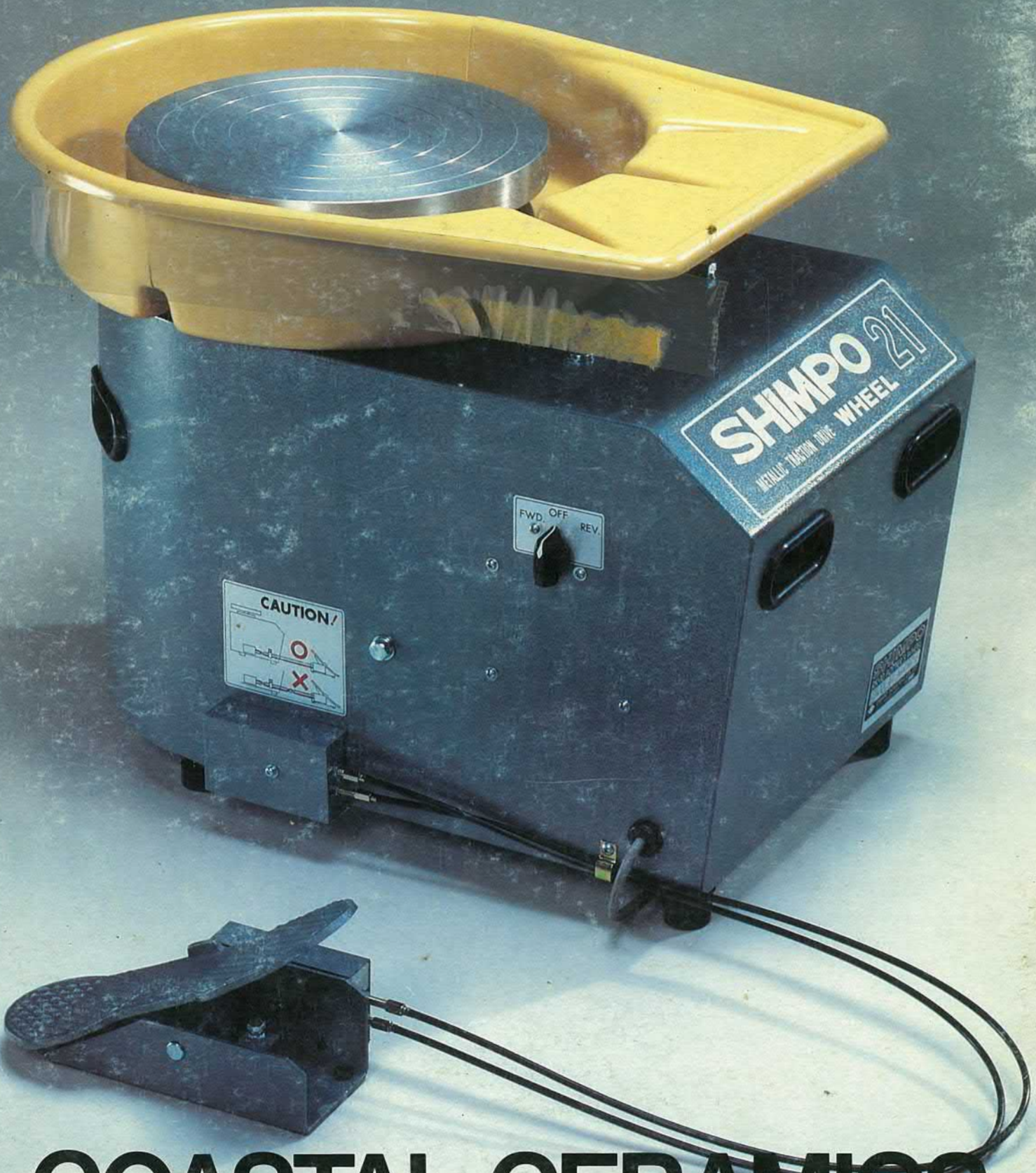

COASTAL CERAMICS

124 RIMU ROAD, PARAPARAUMU ● PHONE 058/84377 PARAPARAUMU

WRITE FOR FREE PRICE LIST